

tony PAPIIN

BILD

Tony Papin

BILD

$365 - 11 = 354$  dessins



- a) je réfléchis
- b) je tousse
- c) je me lèche  
la main



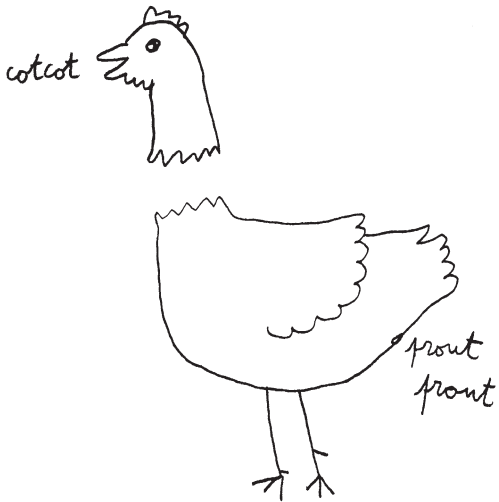



tête d'allumage  
tête de pêne

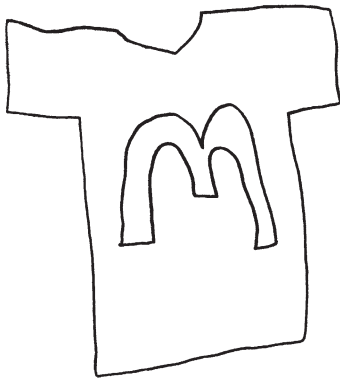

le tee-shirt de Che Guevara

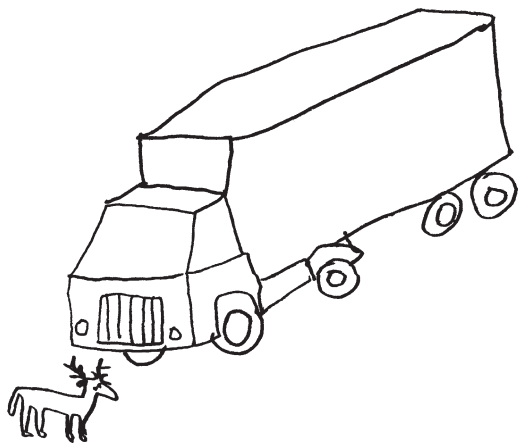



# LA PATATE QUI CHANTE





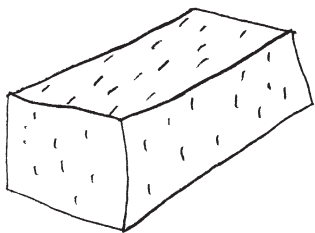

crottes  
de brique

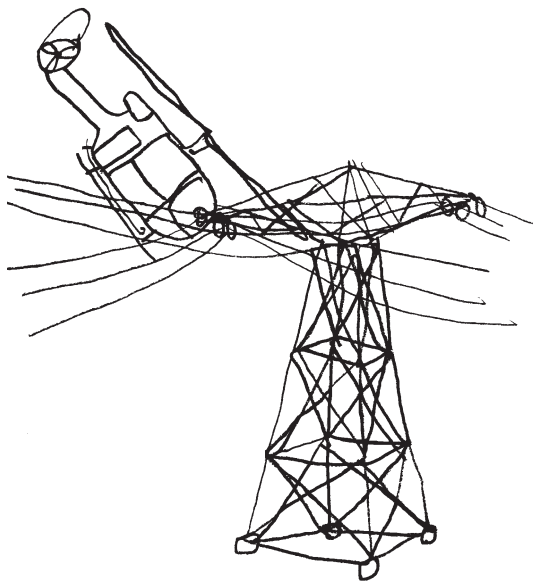

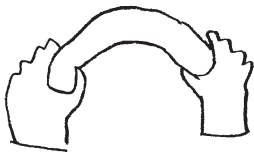
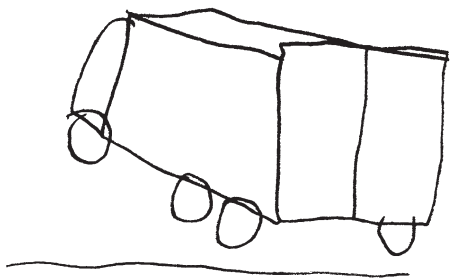

(quand je double un  
camion) je serre très  
très fort le volant

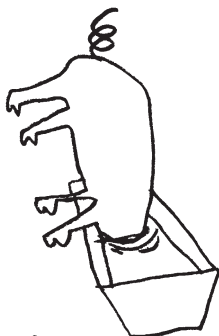

il a soif  
le cochon



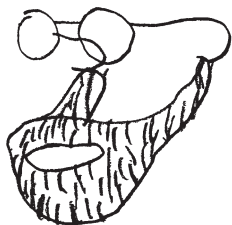

déguisement de  
Freud



Z O M

B I E

ça fait peur

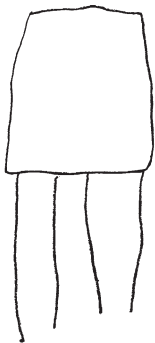

Tu es  
trop jolie  
en jupe

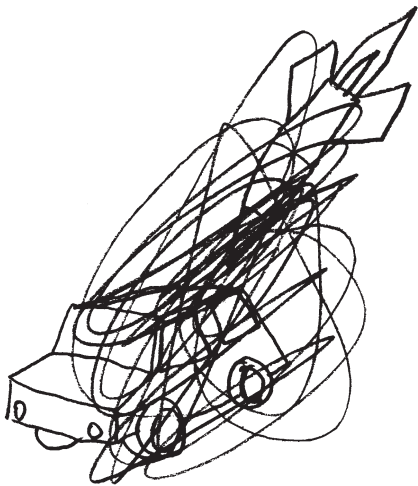

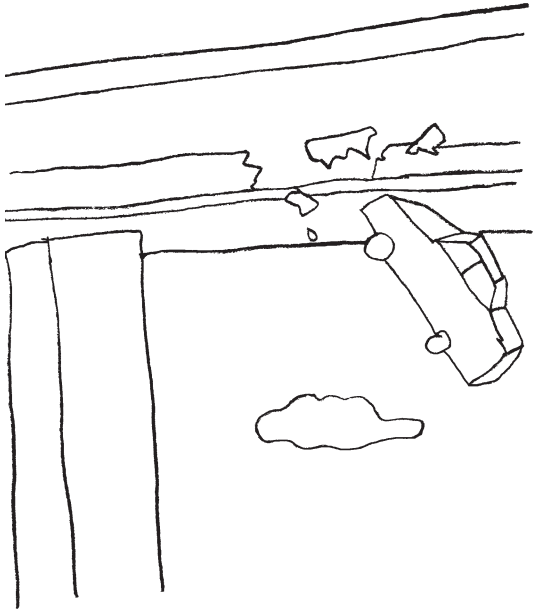

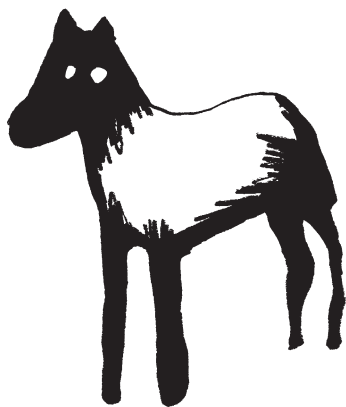



LA VENGEANCE DE LA  
MONTAGNE

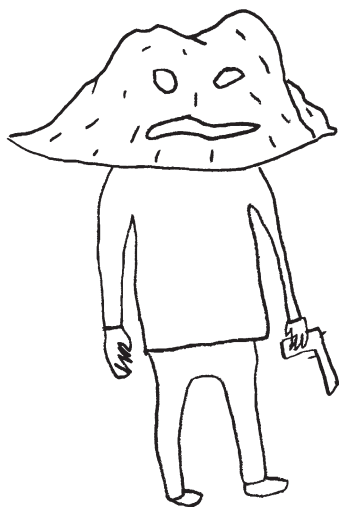

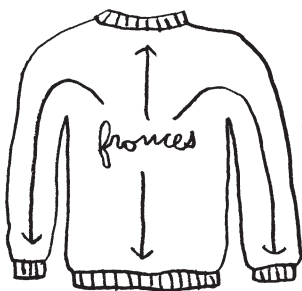

sweat  
shirt



tee shirt  
à  
manches  
longues



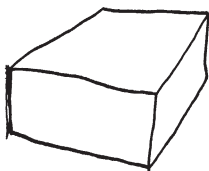

1- kiti

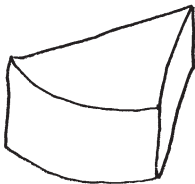

2- Vache  
qui rit

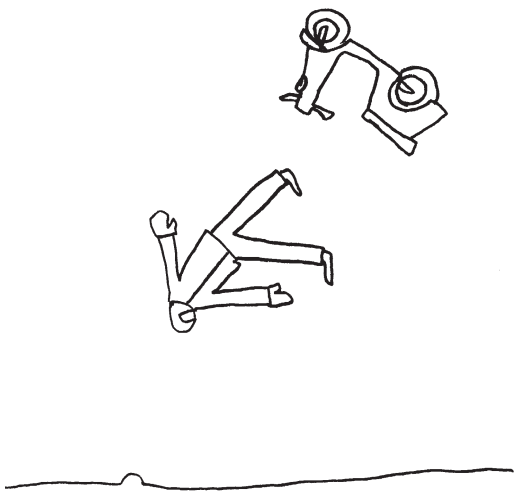

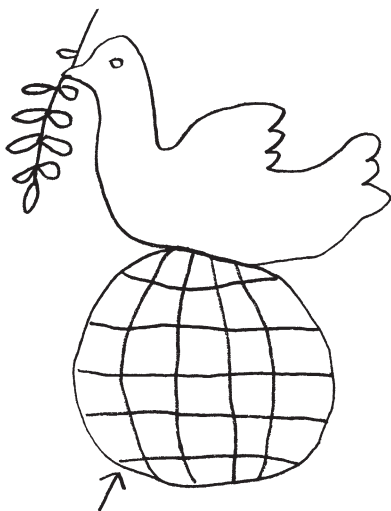

DU GRILLAGE

LE MANS

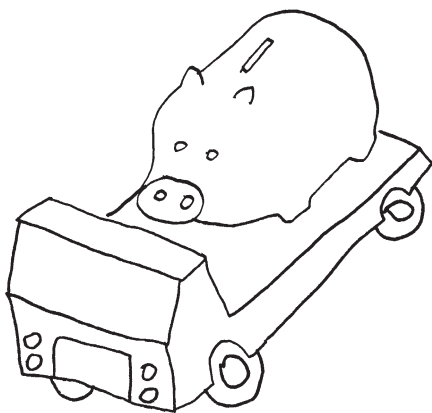

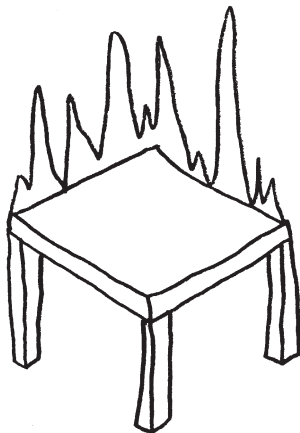





voici arme

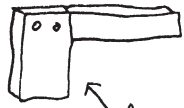

fausse  
arme

voici  
arme



boule de Noël



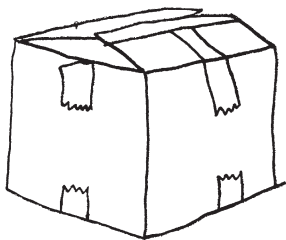

SQUARE BOXES





it's not  
the L.P.  
version

I can hear the  
best from where  
I am

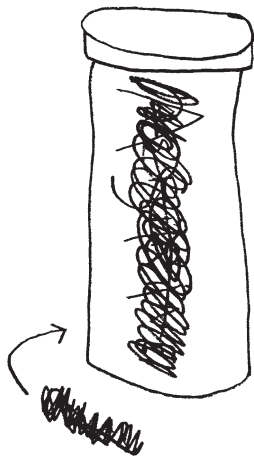

B R A V O

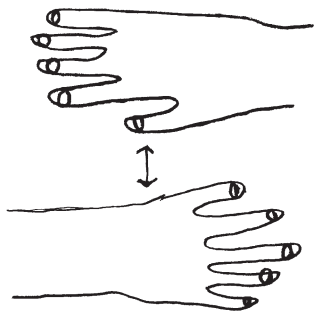



drug dealer in  
the park



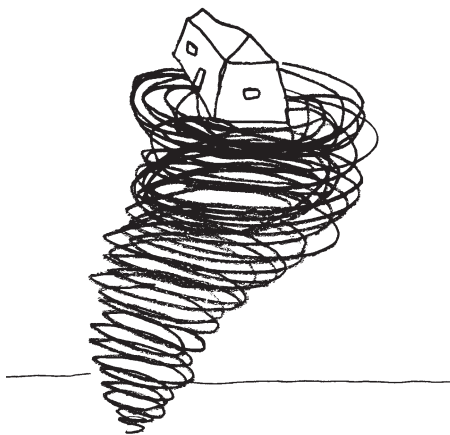



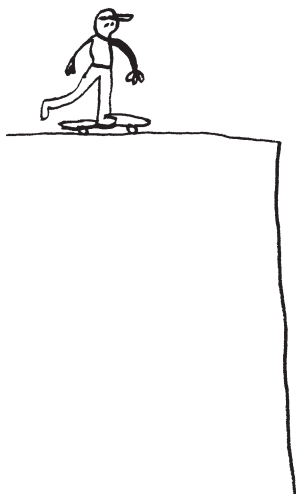

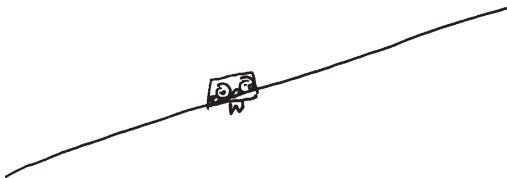

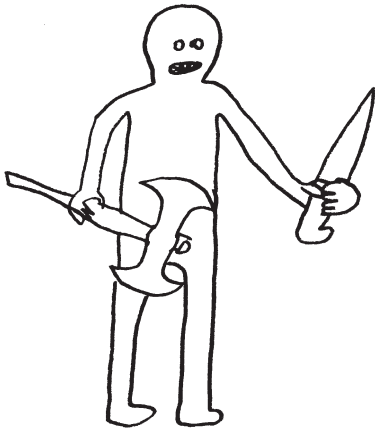

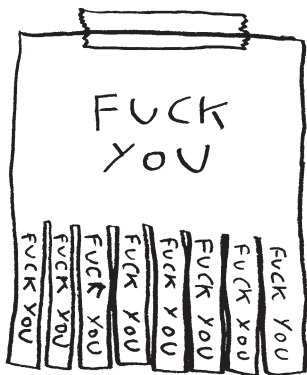

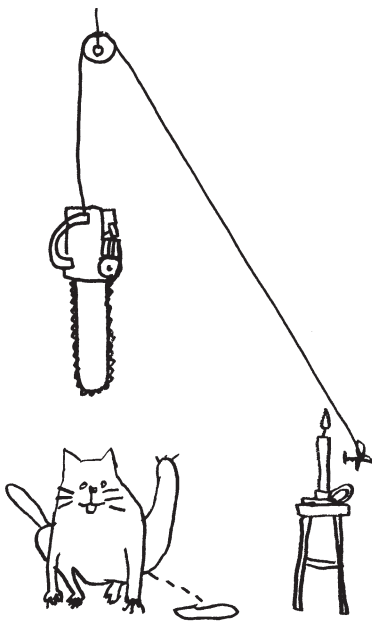



# EXERCICE 1



REFAIRE SON LACET

## EXERCICE 2



ENJAMBER  
UN OBSTACLE



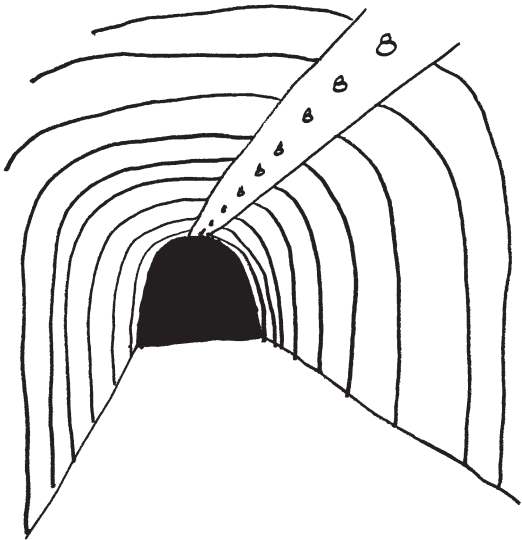

EXERCICE 3

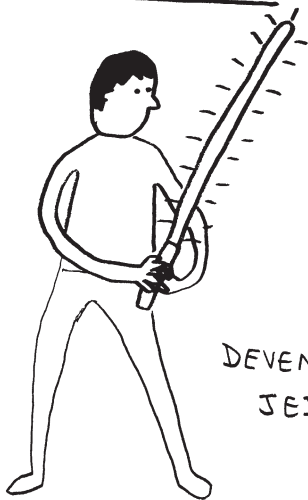

DEVENIR  
JEDI

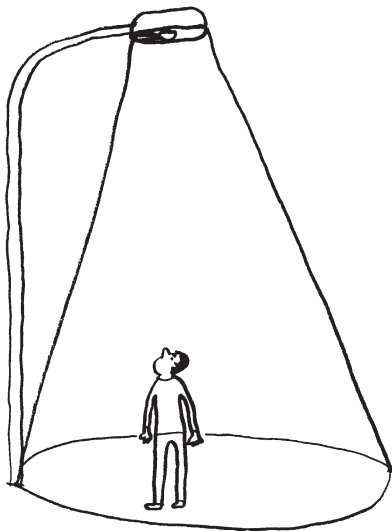

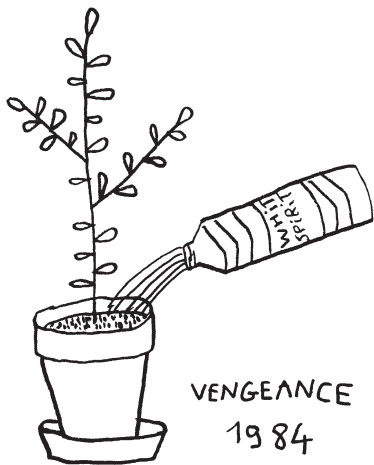

VENGEANCE

1984

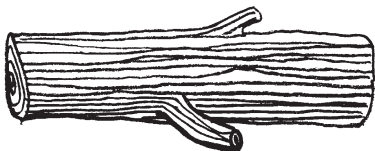

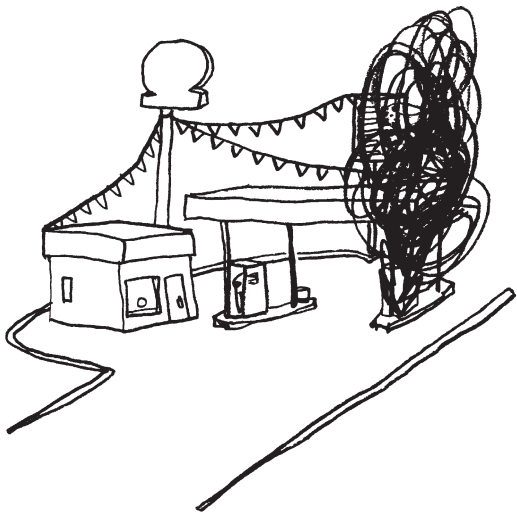

PAPIER  
CREPON →

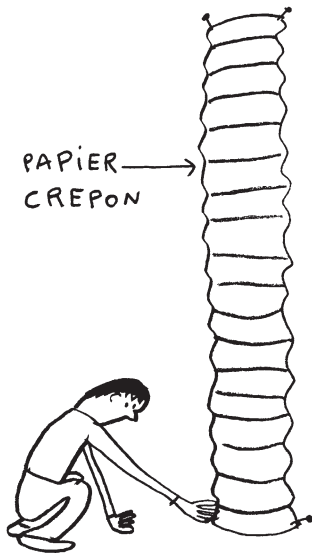

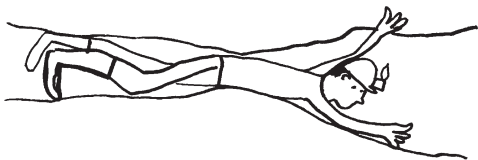





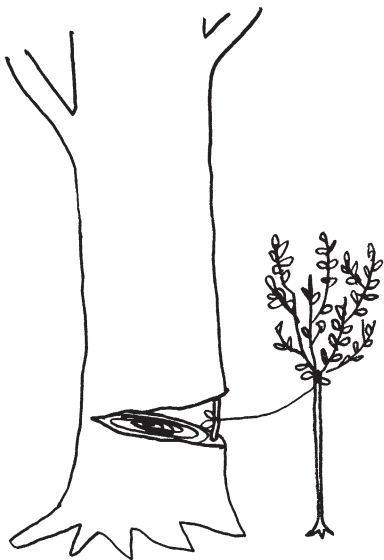

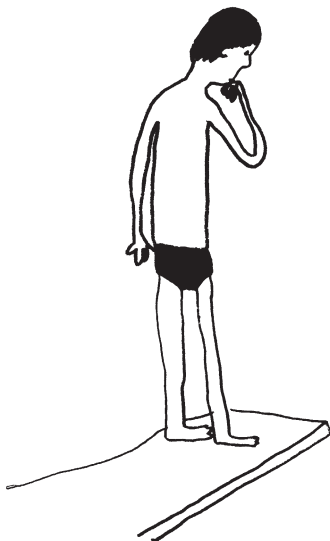

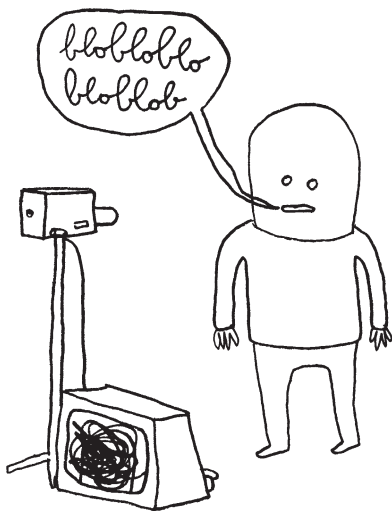



À VENDRE  
( POUR  
PIÈCES )



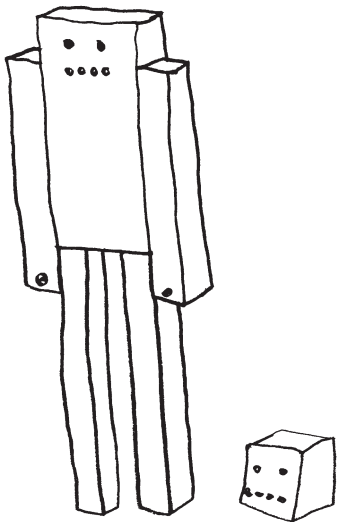

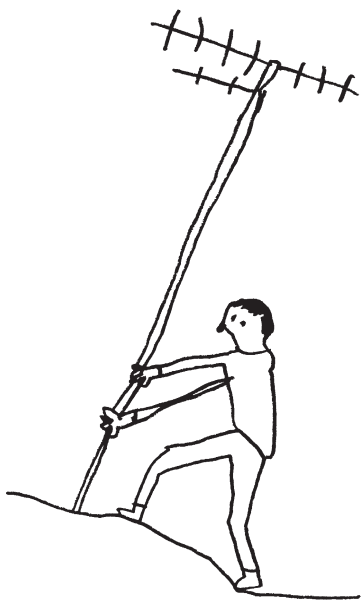

NON



mon vieux T-shirt des  
wedding present ne servira  
JAMAIS à nettoyer les vitres.



ce n'est pas  
la vraie tour  
Eiffel. c'est une  
très mauvaise  
imitation

"MADE  
IN CHINA"  
alors c'est  
pas grave



KAWAI

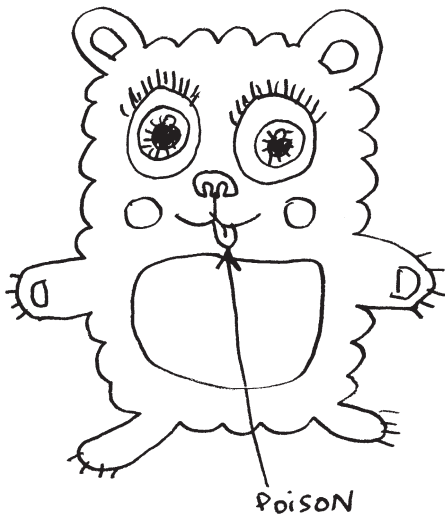





le néon

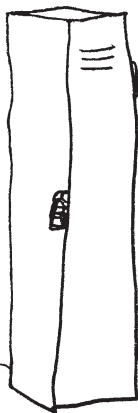

← ton casier

toi, à la fin de  
ta journée de  
travail

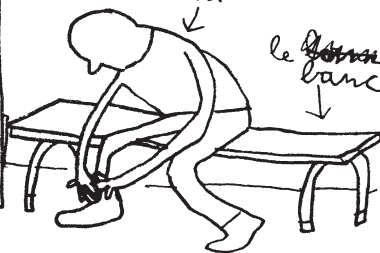

le ~~bon~~  
banc



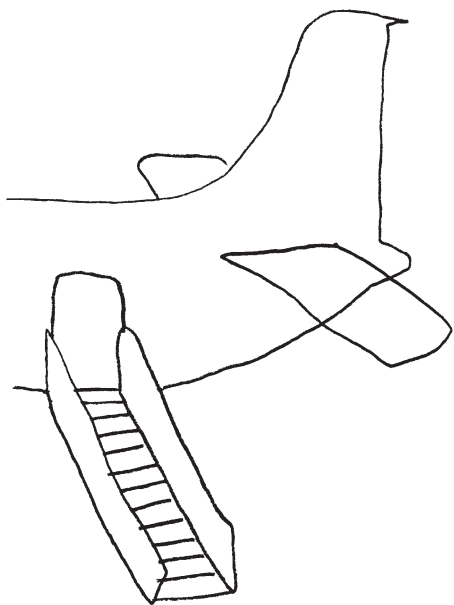

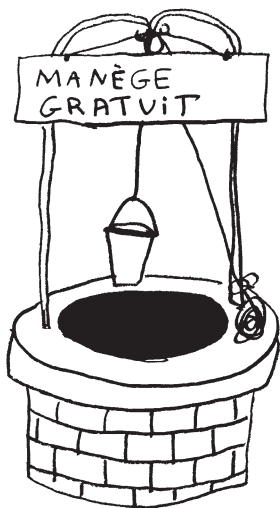



VERS PARIS

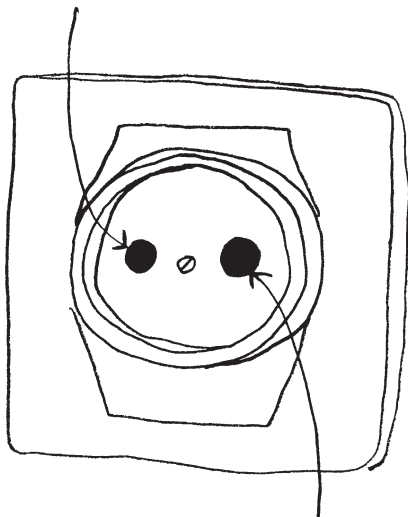

VERS LONDRES



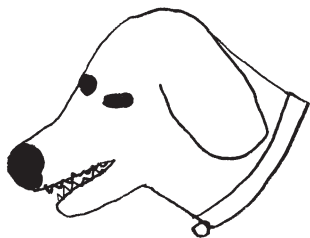

TÊTE DE CHIEN (méchant)

LES SOIRÉES  
C'EST LA  
MERDE

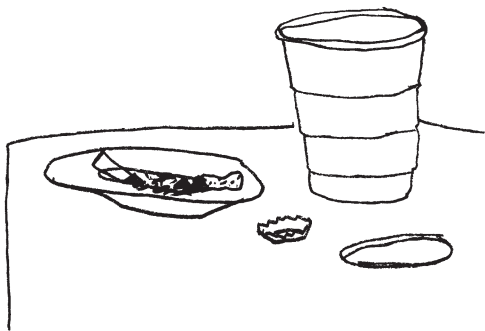

MOUNIR,  
IL A L'AIR GENTIL  
MAIS IL PARLE  
PAS.

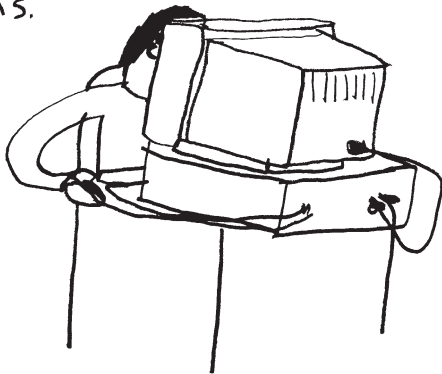



mais  
qui sont  
tous les  
gens ?

LES  
SOIRÉES  
C'EST  
LA  
MERDE

CHEW BACCA

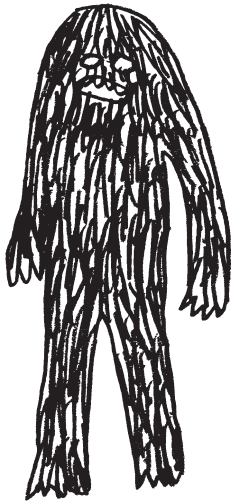

LES SOIRÉES C'EST  
LA MERDE

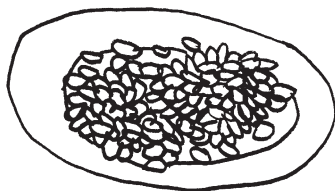

suis-je capable de  
manger toutes ces  
cacahuètes?

normalement ce dessin  
est plein



de couleurs

ET IL EST  
MAGNIFIQUE

je veux rentrer  
à la maison

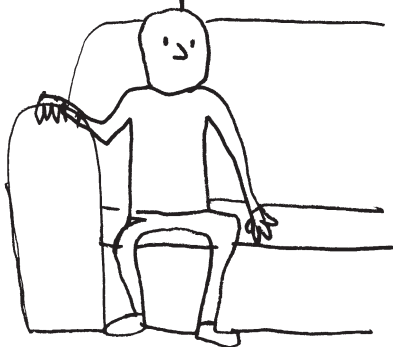





collection printemps  
été

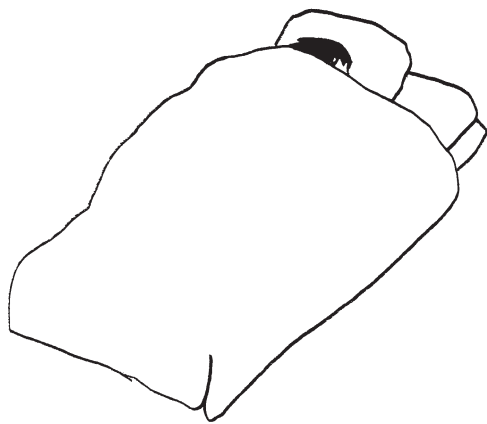









ERRERUR

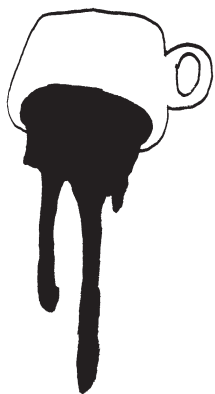





COLORIAGE

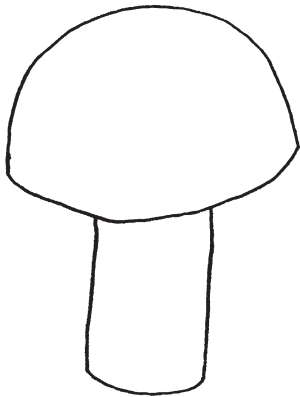

MASTER MIND  
(on gagne à chaque fois)



dans le noir  
personne ne  
peut te voir



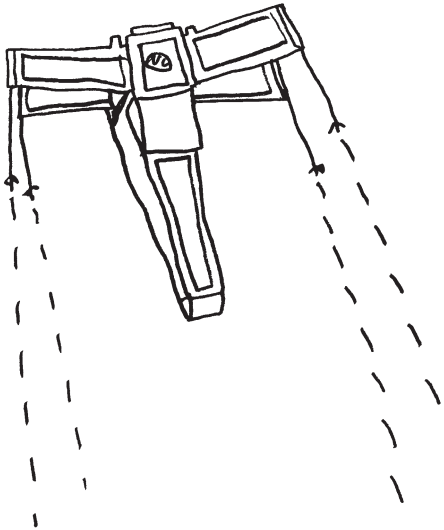



je ne suis  
pas  
une  
putain  
de  
plante  
verte.





PUNK ROCK  
+ CONSTRUCTIVISME

①



black  
Flag

②

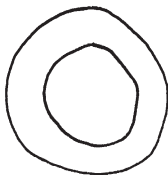

the  
germs







flute, j'ai  
acheté  
mon  
pantalon  
neuf...

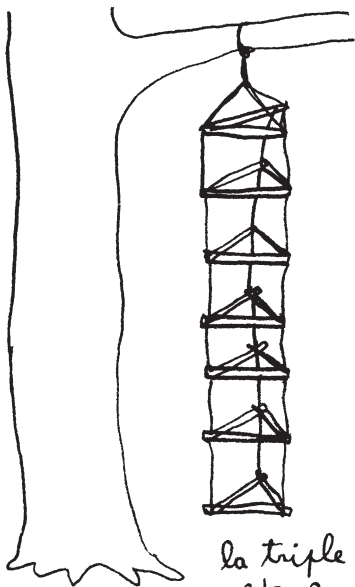

la triple échelle  
de l'école maternelle

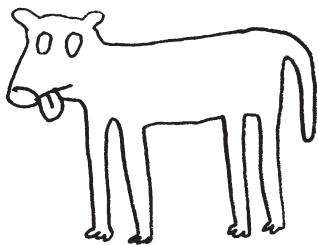

VEAU-CHIEN

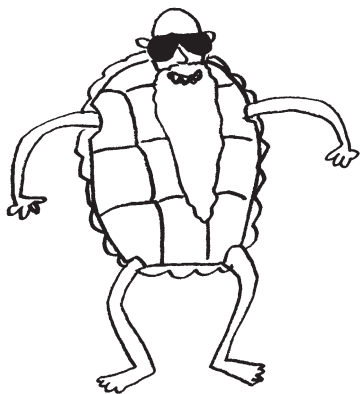

TORTUE GÉNIALE



WILD RABIN STYLE

il est pas  
un peu chaud  
le petit ?

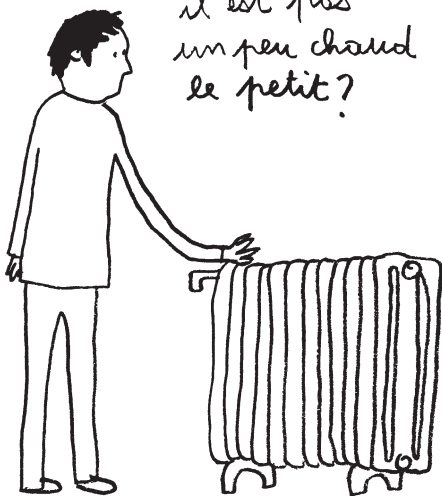

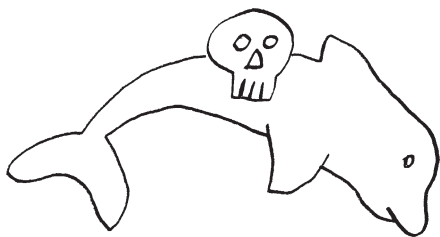





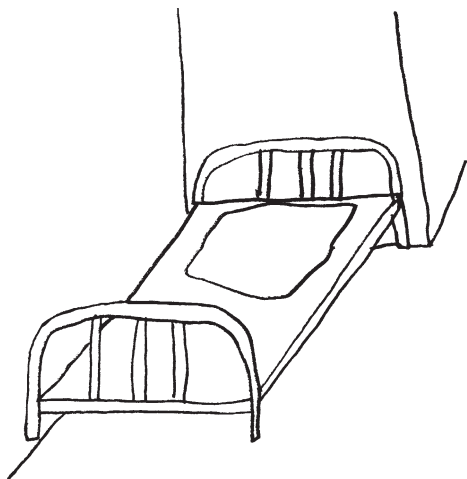

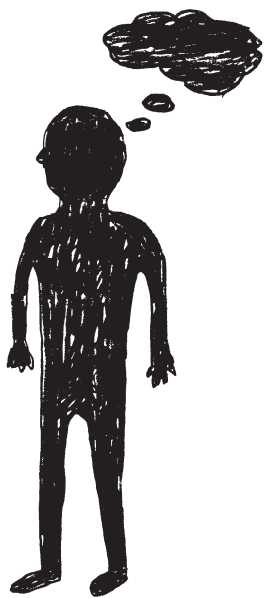

DROITE

GAUCHE

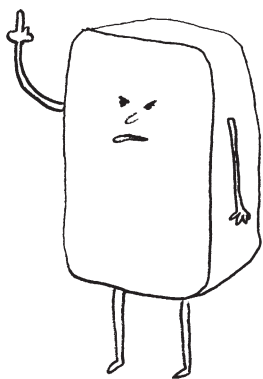

LE SAVON

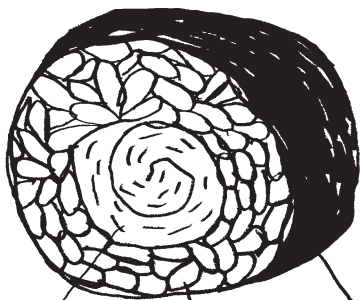

Poisson  
CRU SANS  
GOÛT

RIZ NATURE  
ET COLLANT

ALGUE  
SANS GOÛT

FINALEMENT LES SUSHIS C'EST  
PAS TERRIBLE

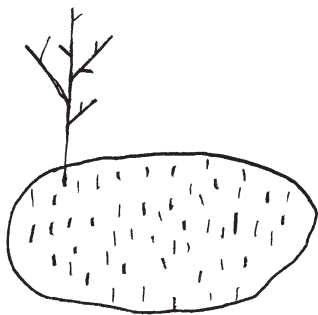

central park

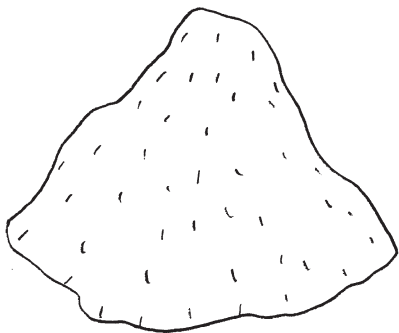

un gros tas de n'importe  
quoi



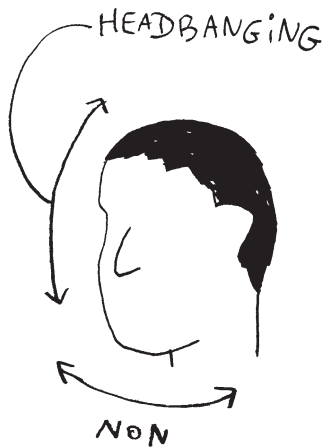



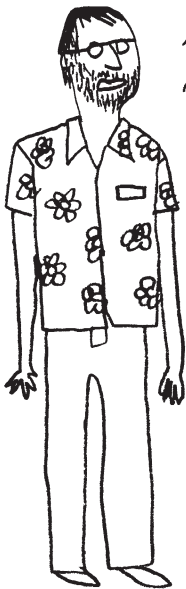

un jour ma mère  
m'a dit "Tony  
vas t'faire couper  
les ch'veux".

J'ai répondu  
"D'accord maman  
si tu veux..."  
oh yeah

je ne vous  
abandonnerai  
pas

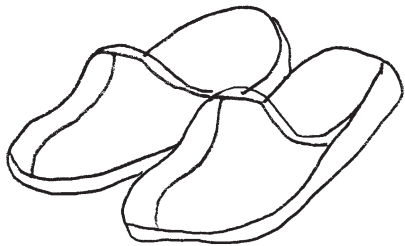

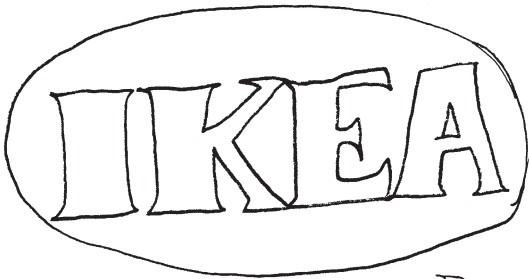

LAND

à l'heure du thé,

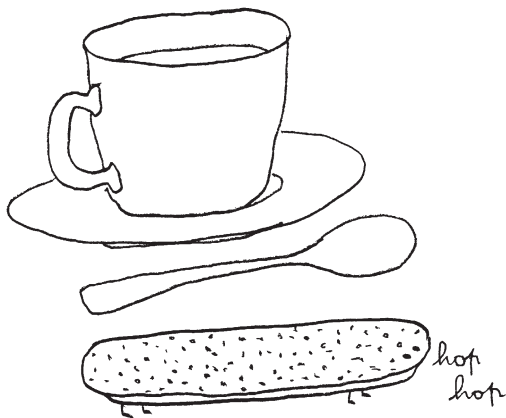

le bousoir se fait la malle.

PUNK NOT DEAD

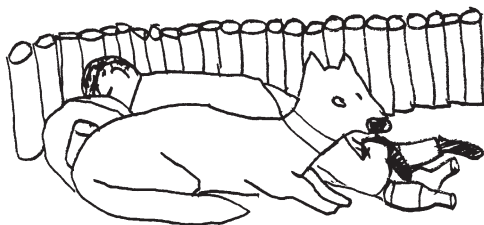

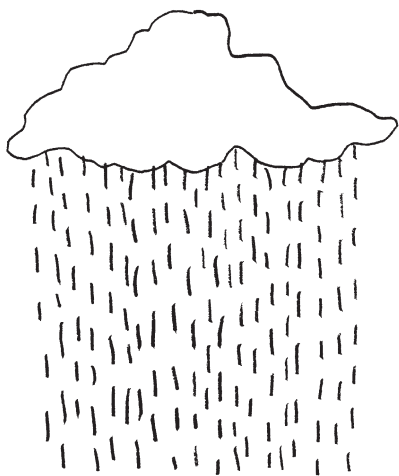



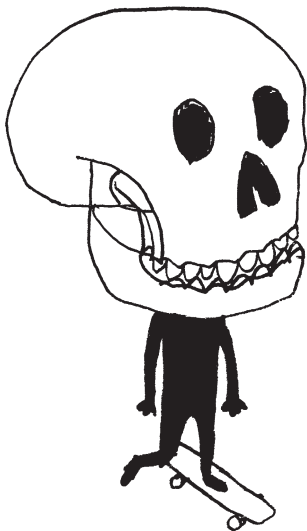

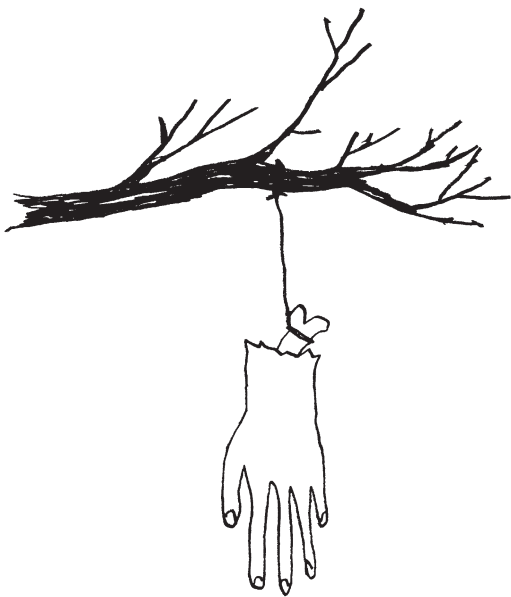



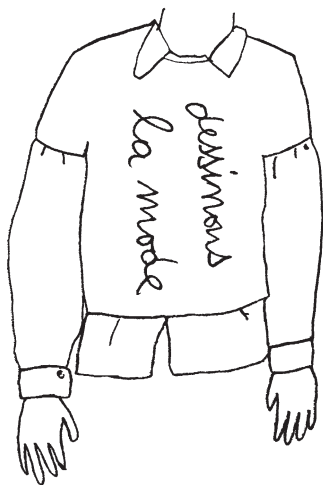

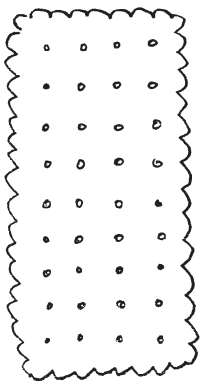

pain de guerre

born to clean

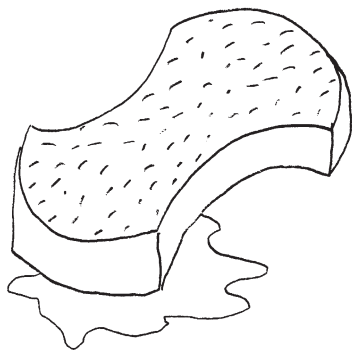

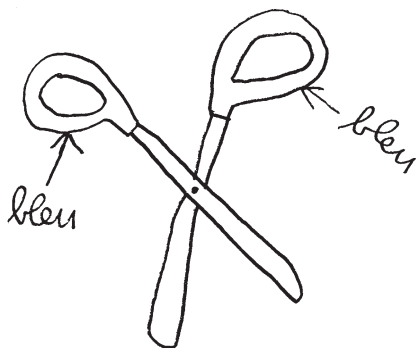

j'ai encore perdu  
les petits ciseaux  
bleus

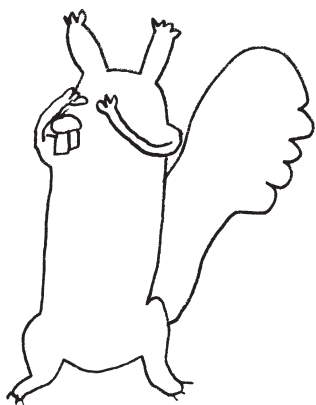



ARTISTE CONCEPTUEL



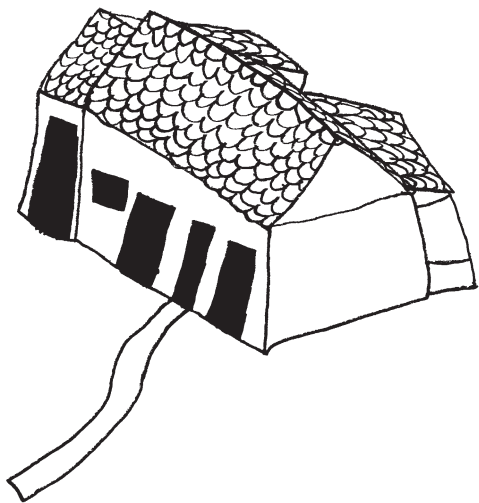

VIDÉO EXPERIMENTALE

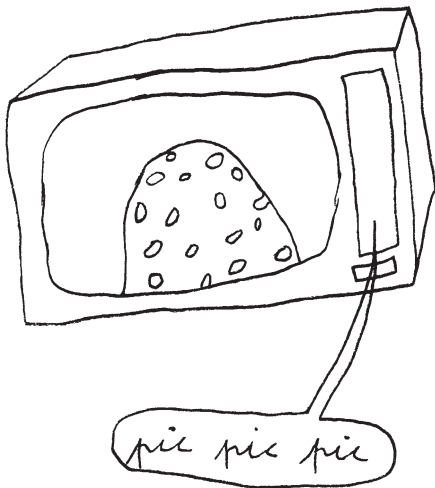

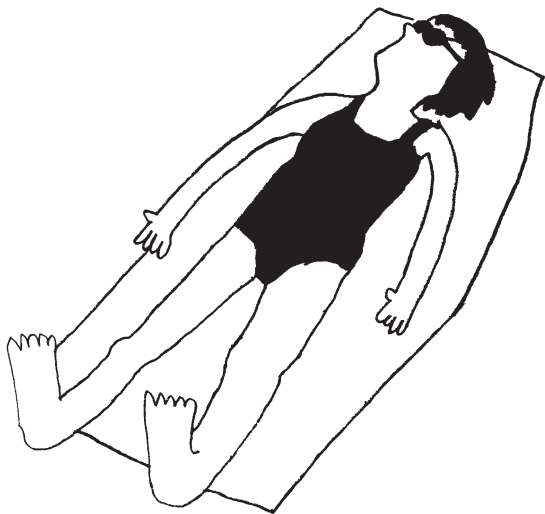

fucking little bastard

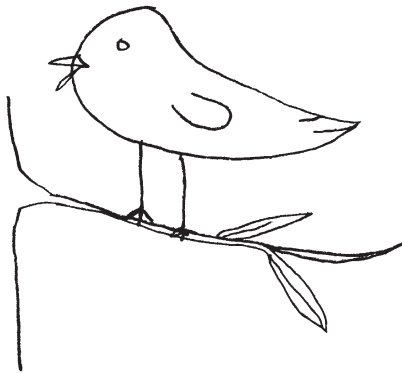

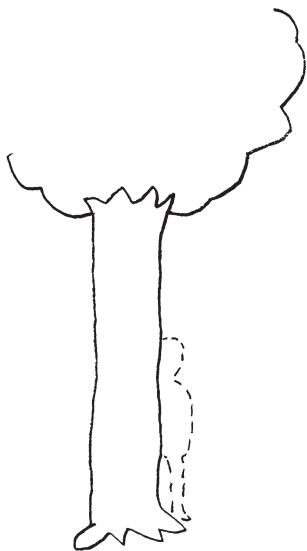



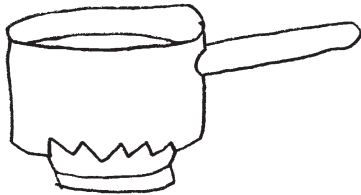
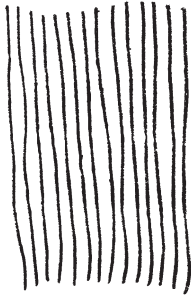

spaghettis



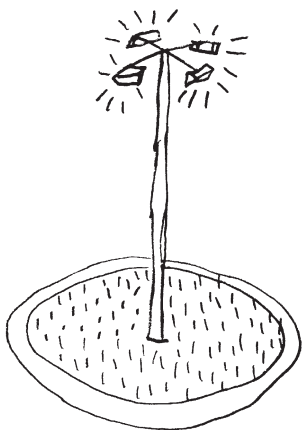

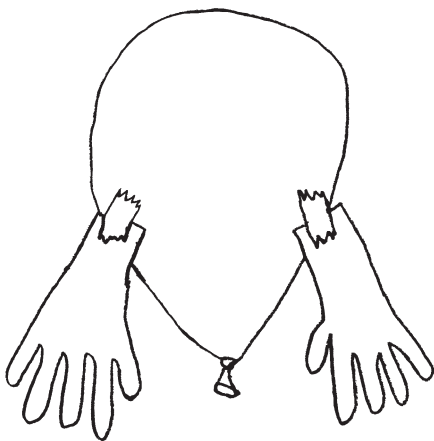

*le stagiaire*

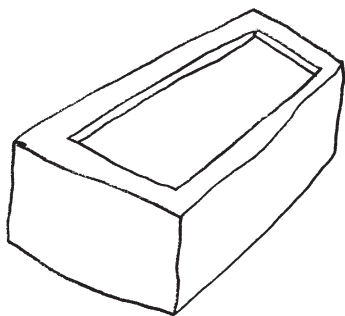

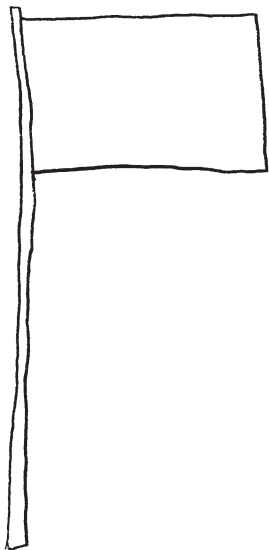



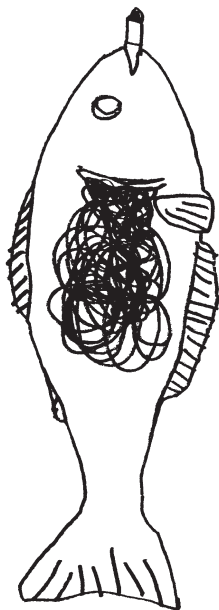

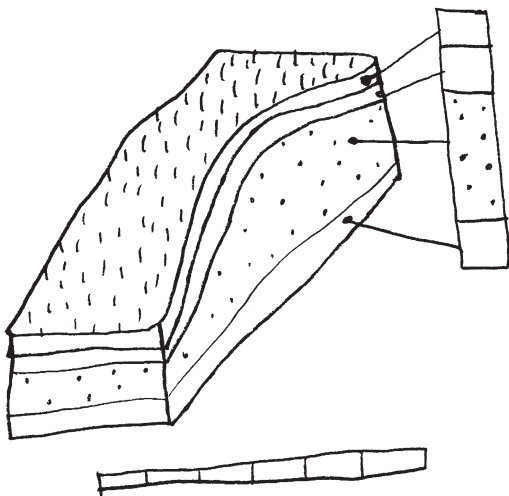

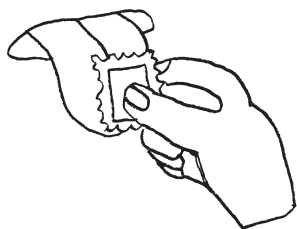





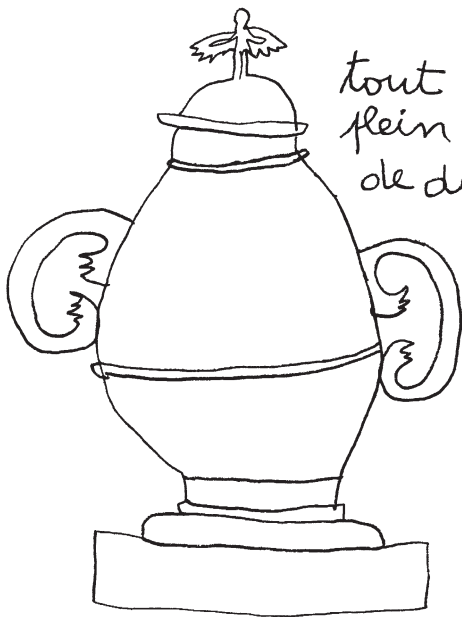

tout  
plein  
de doré



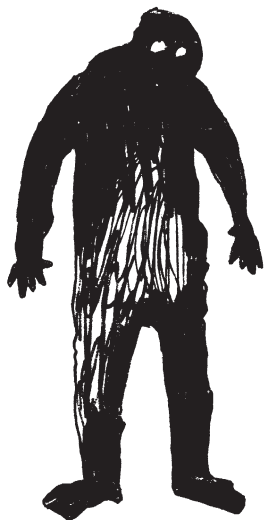

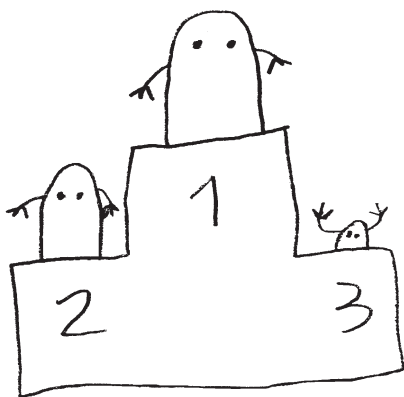

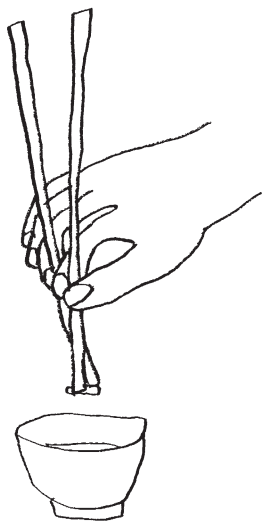

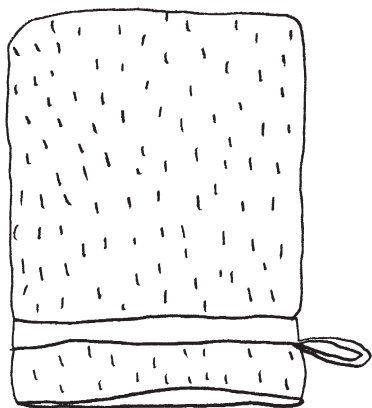

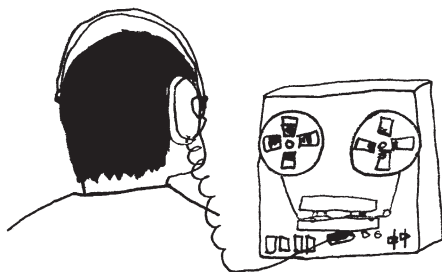



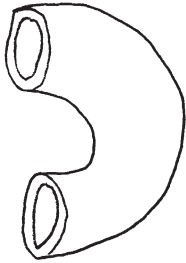

les coquillettes  
=  
haute technologie



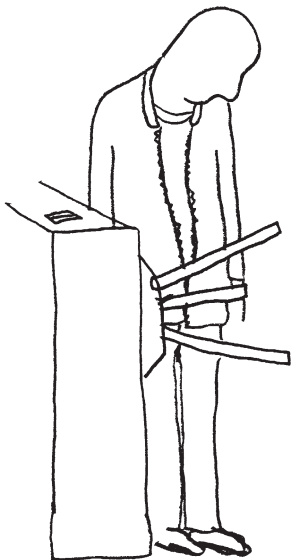

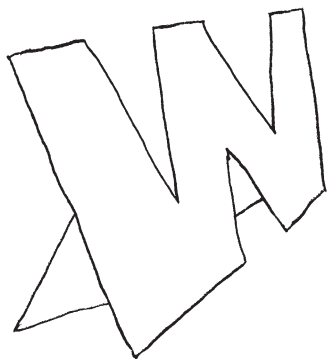

Un t-shirt aux couleurs  
du drapeau de son pays

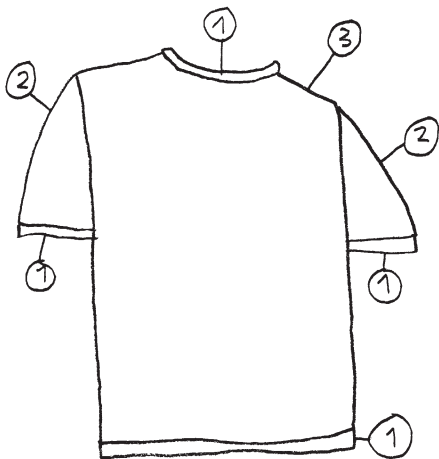

- ① - première couleur du drapeau
- ② - seconde couleur du drapeau
- ③ - troisième couleur du drapeau

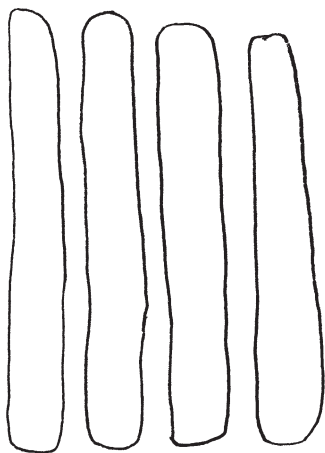

knachies



la brume

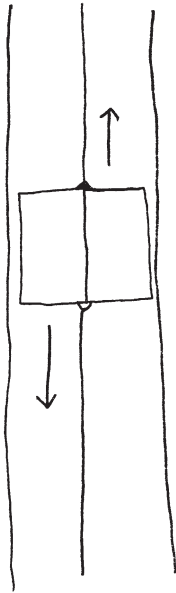

LIFT



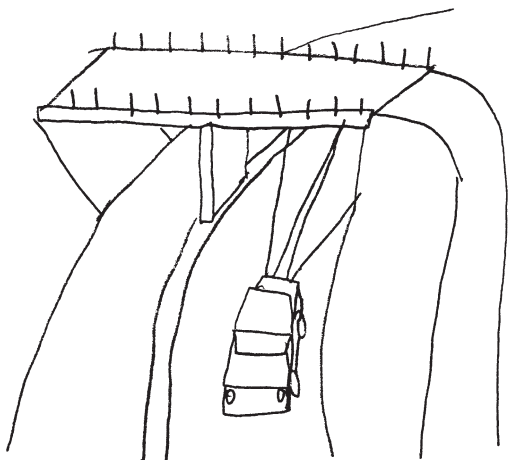
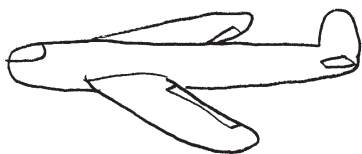

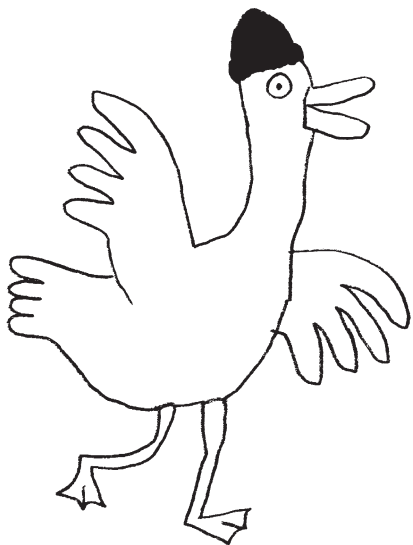



REVENGE



j'ai résisté



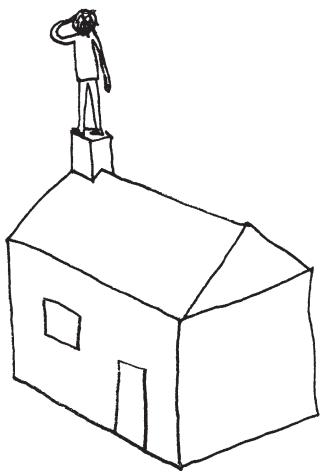

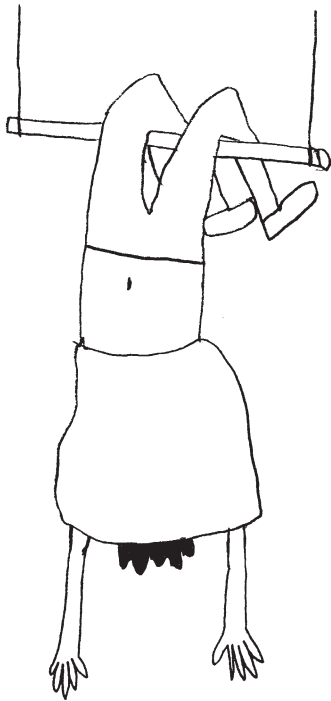

rébus

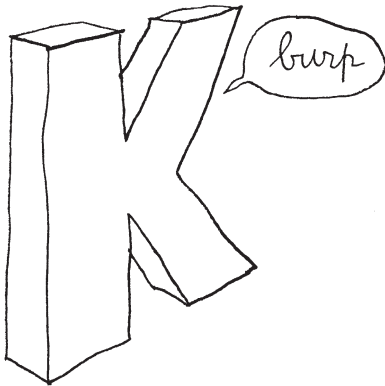



la danse,  
c'est MAL

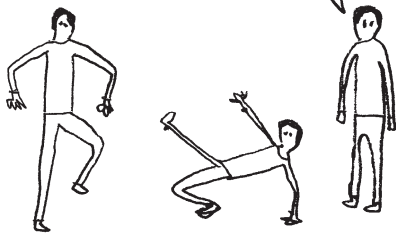



SATA / Nic  
BOW / LING

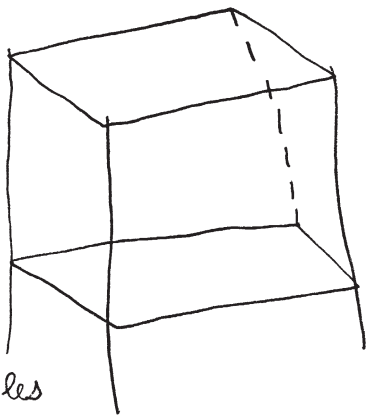

les  
lits  
superposés





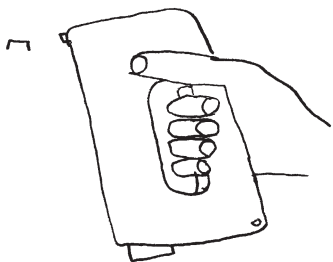

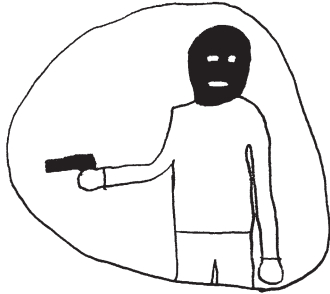

Mounit a dit m'avoit  
vu faire des tours  
de magie à La  
braderie.

*abracadabra*





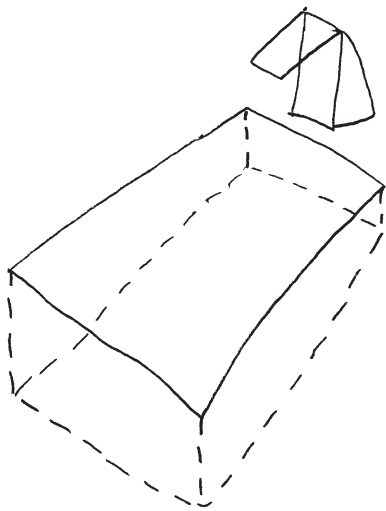

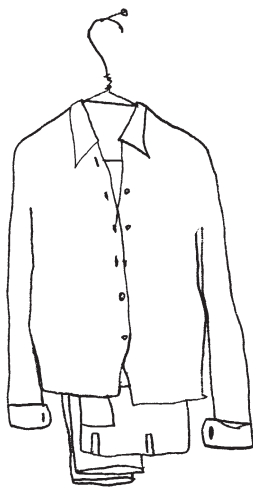

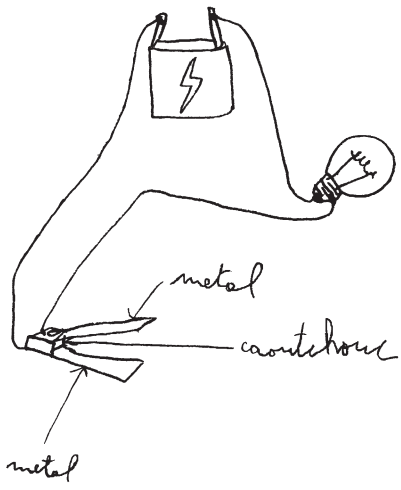

ne pas paniquer

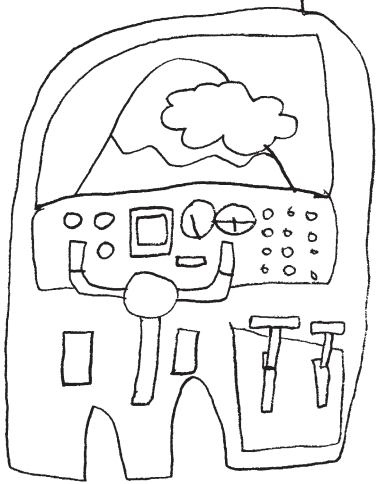

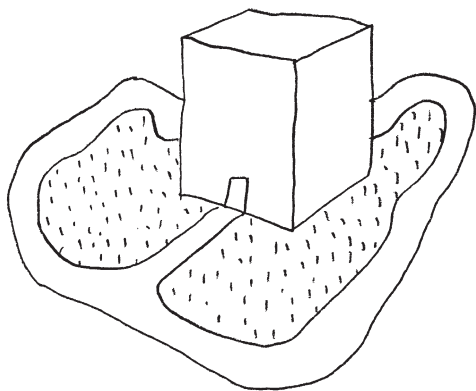

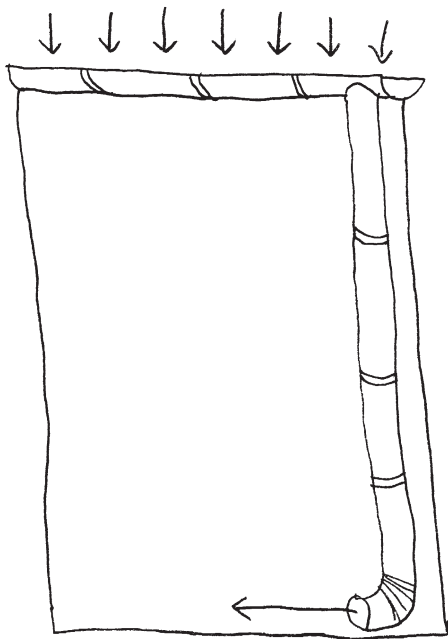

MON RECORD

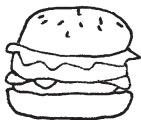



hey! l'père  
la binocle!





C'EST VRAIMENT PAS  
RAISONNABLE



la fourrure

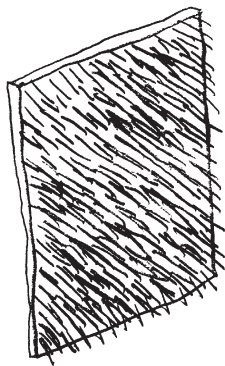

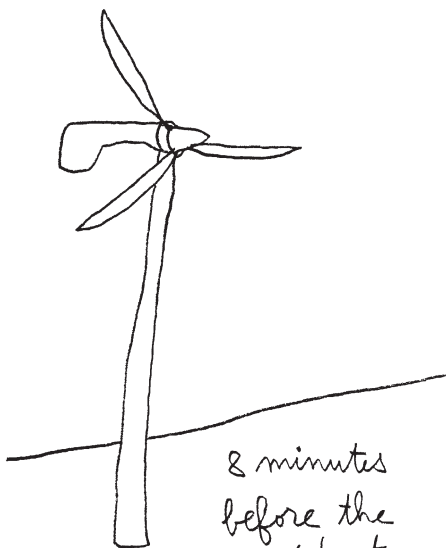

8 minutes  
before the  
accident

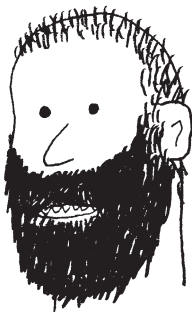

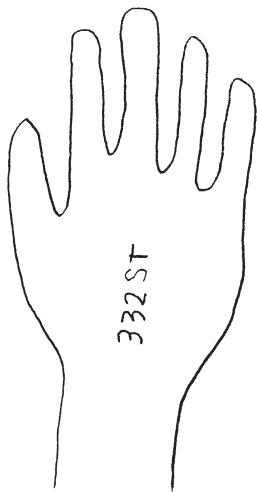

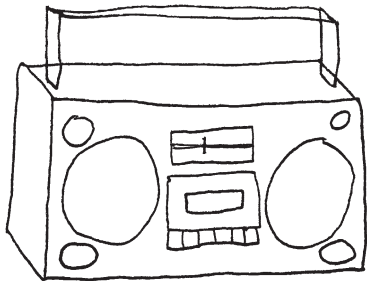

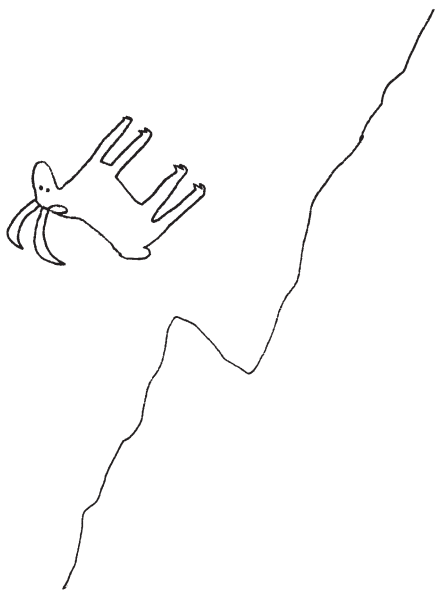



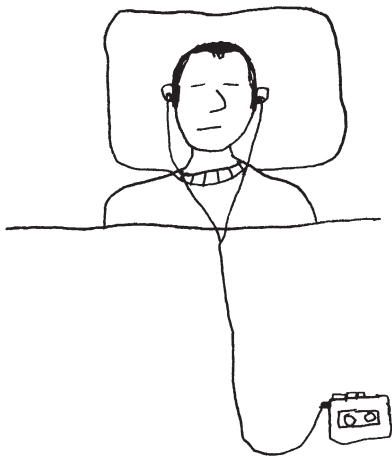

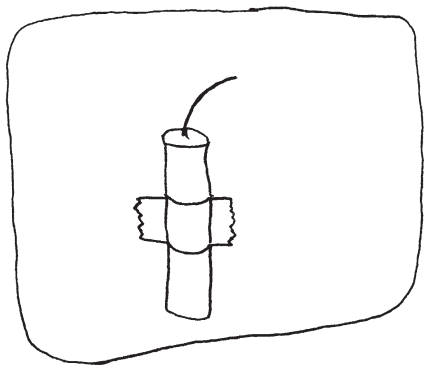

INCROYABLE

VOTRE NOM ICI

Votre prénom sur  
un grain de riz  
de 12 km de long



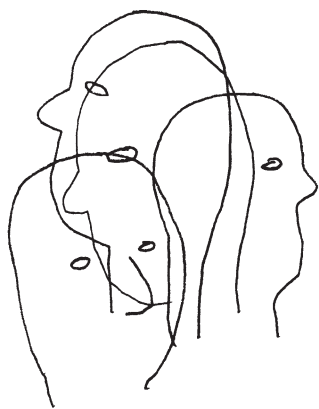

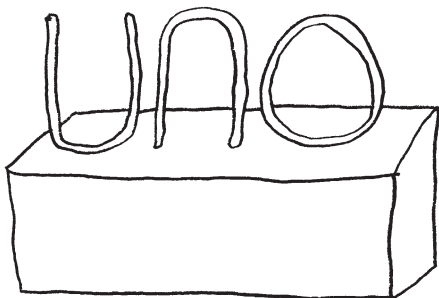

ÇA VEUT DIRE "UN"

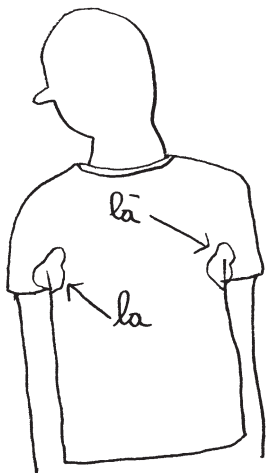

DÉFAUT n°1

combustion spontanée  
de Joseph Beuys

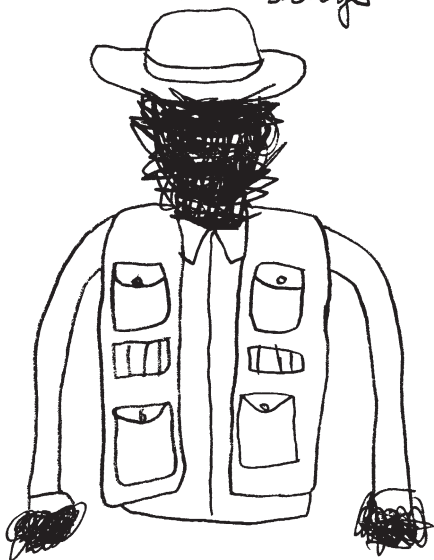



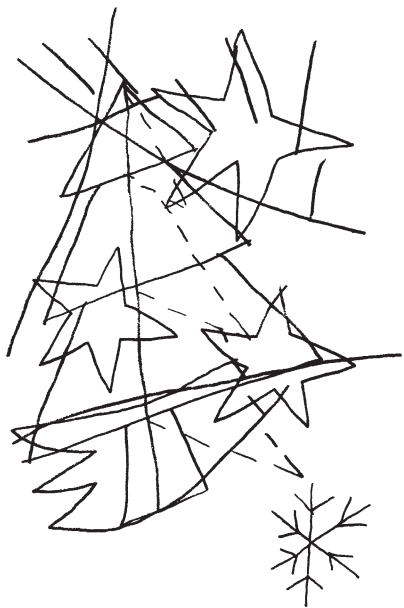

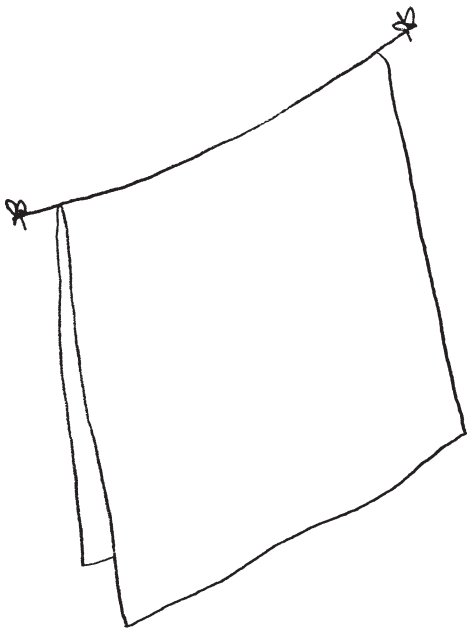

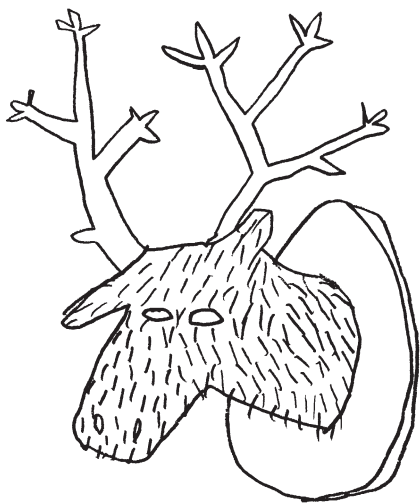



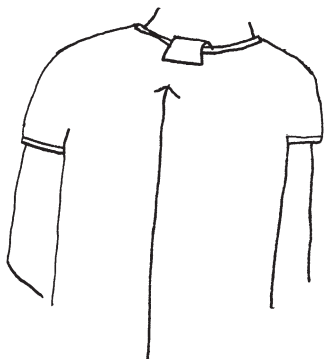

*trop la honte*

A QUEL ÂGE COMMENCE  
L'ANGOISSE DE MORT?



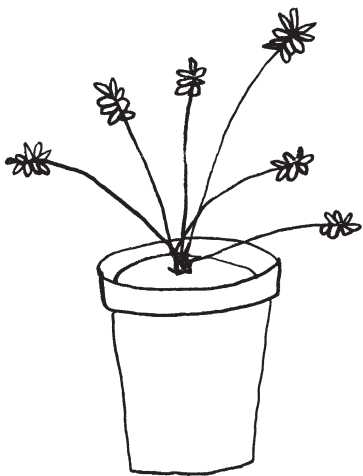

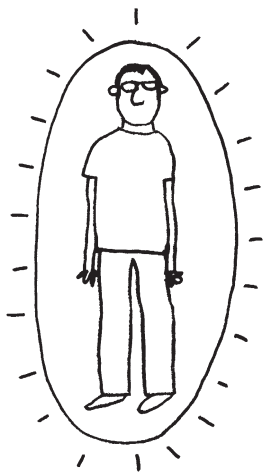

INVINCIBLE



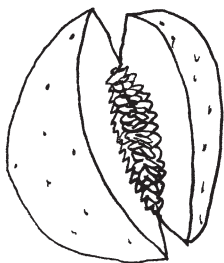



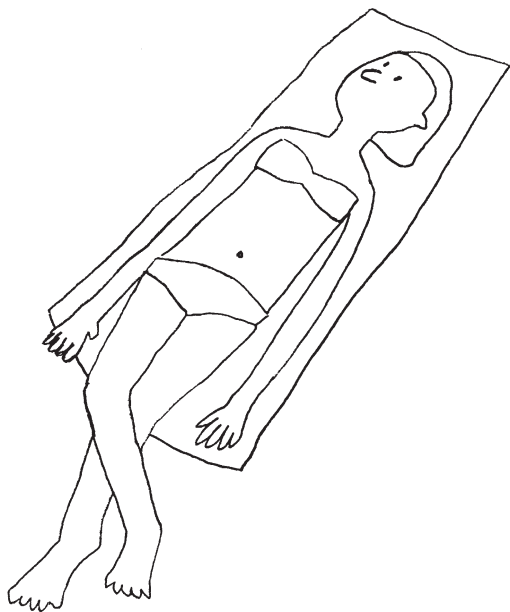



TCHANG

COMMENT OBSERVER  
LES ÉTOILES SANS SORTIR  
DE CHEZ SOI ?

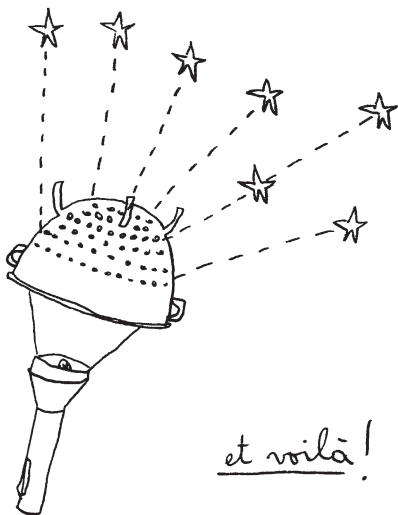

et voilà!





les vendeurs  
d'aquarelles

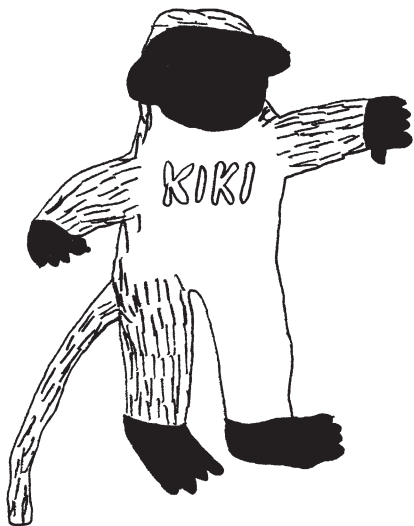



AUGUST

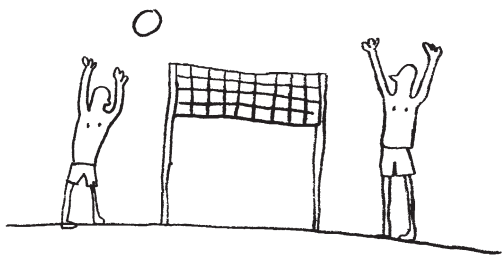







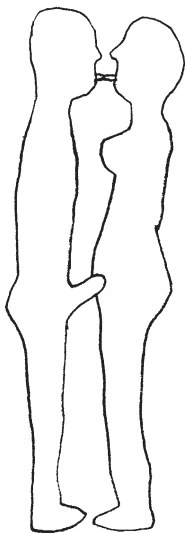





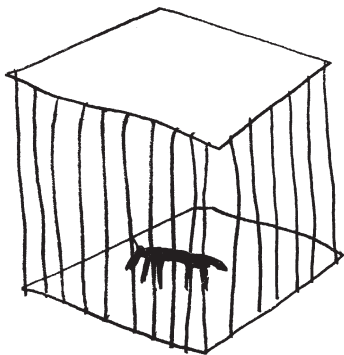



# L'AUTONOMIE

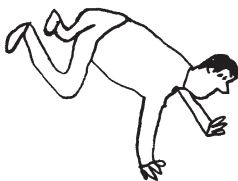

la la la

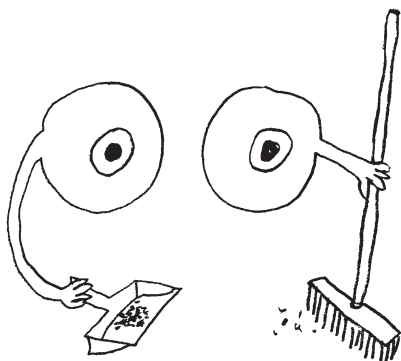

humm, c'est  
dégueulicieux





CAPTAIN  
ASYMETRIQUE

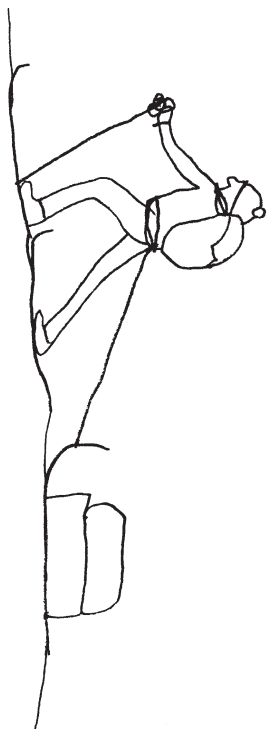

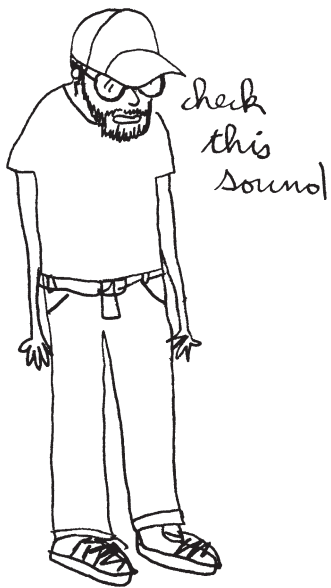

# CHORÉGRAPHIE

①



②

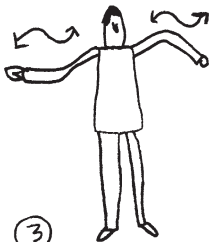
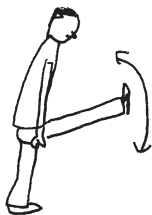

③



④

je ne suis plus trop  
primésantier\*

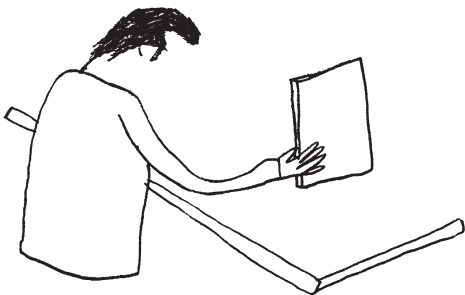



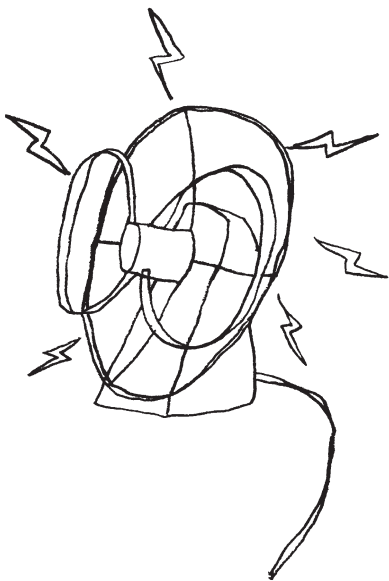

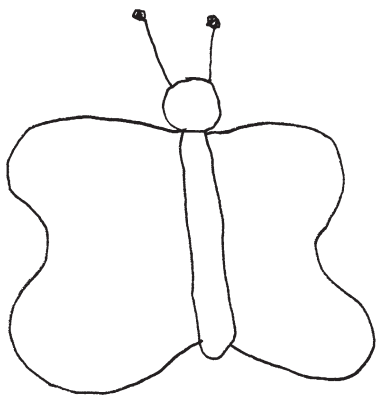



hier, j'ai mangé  
une pizza, mortel  
trop bonne

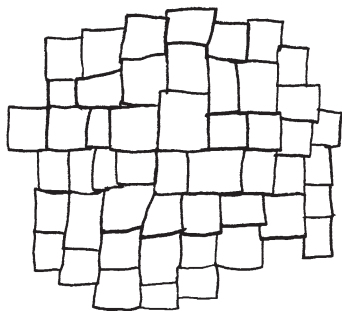



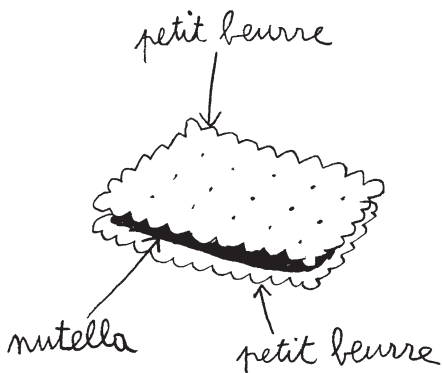

FAUX CHOCO

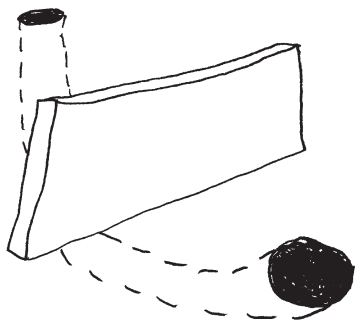

UN TUNNEL  
TRÈS SOMBRE  
^  
TRÈS

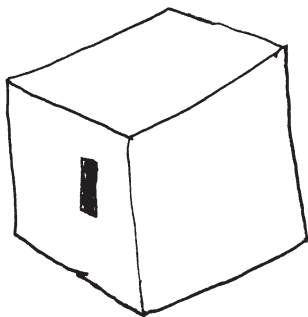

UNE PIÈCE TRÈS  
MAL ÉCLAIRÉE



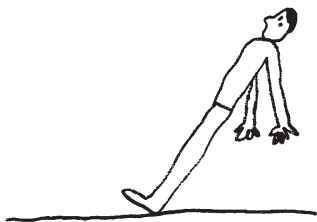

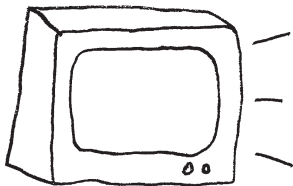

dimanche soir

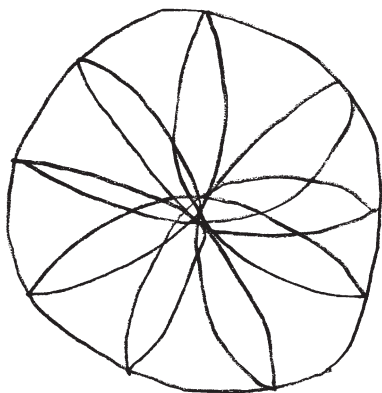

V O M I R

LA FIN DU  
MONDE



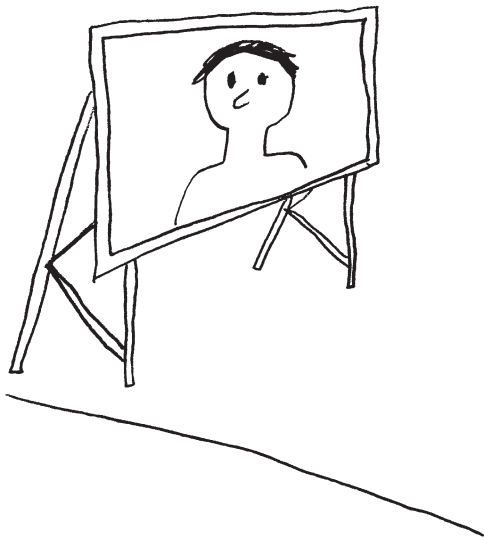

ce qui arrive

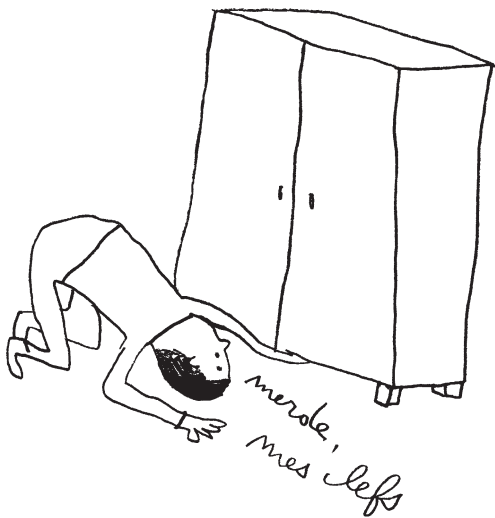



MON PAPA

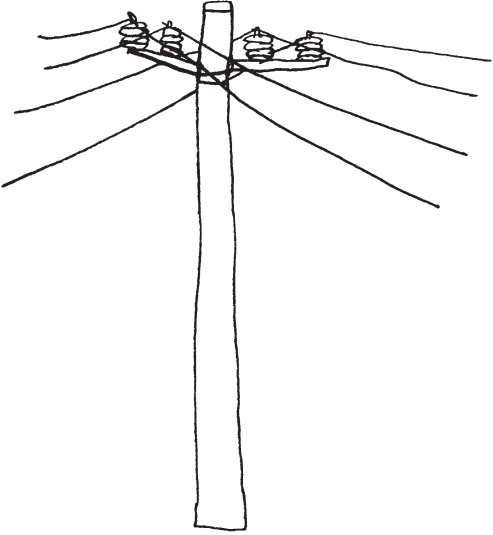





et c'est tout

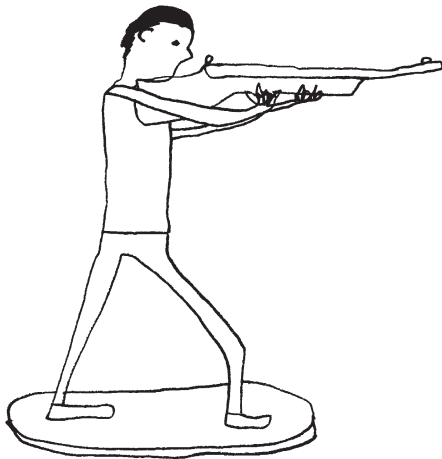



Dieu seul  
me voit

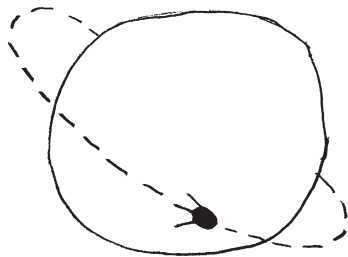

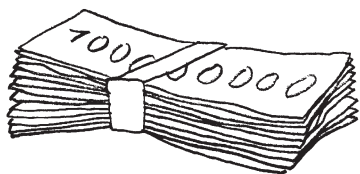



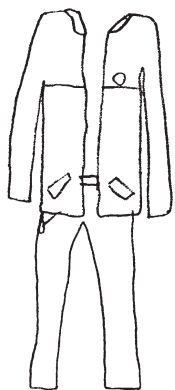





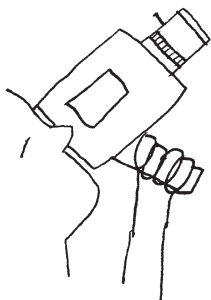





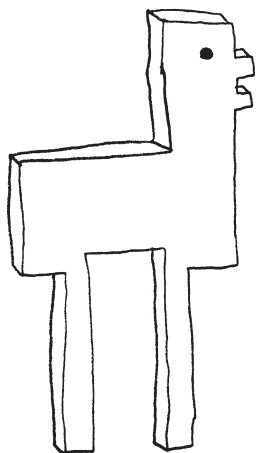

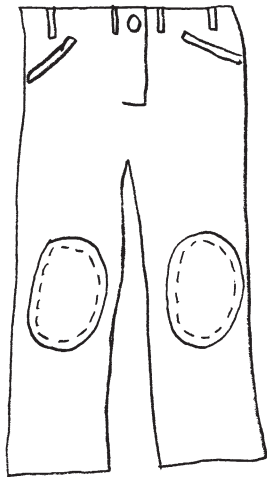

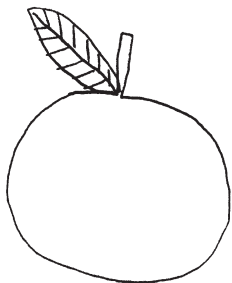

LES FRUITS  
C'EST MAL



ICI : PAS D'ANNIVERSAIRE

TACOS

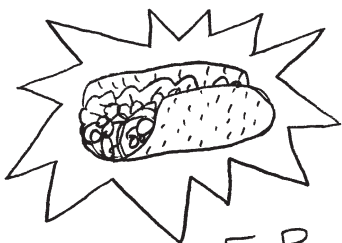

POWER



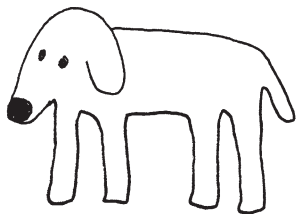

DOG & ~~PONY~~ SHOW

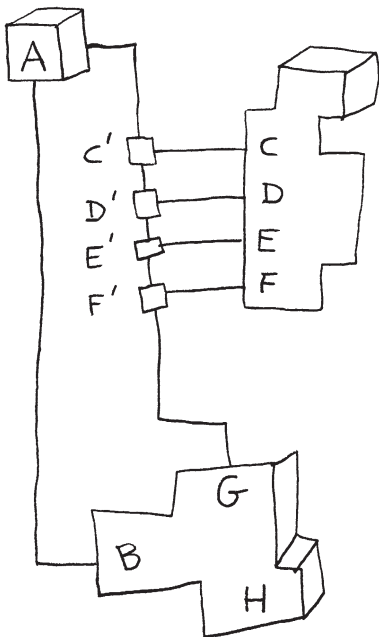

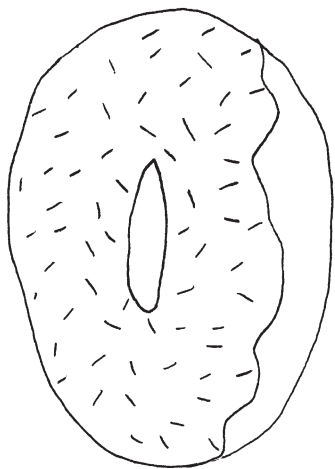

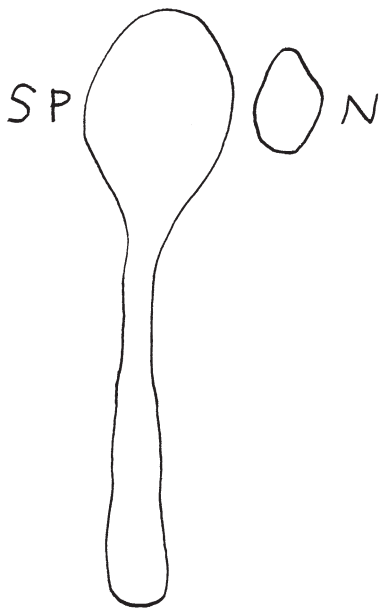

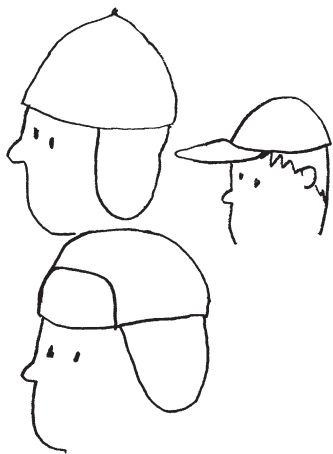

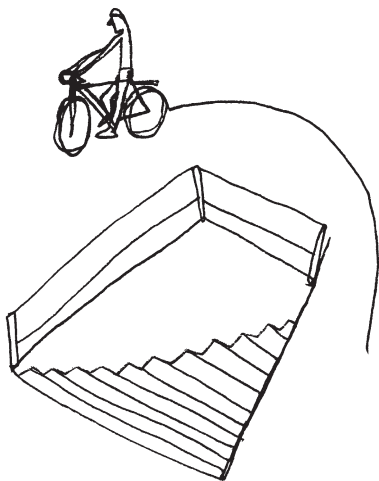

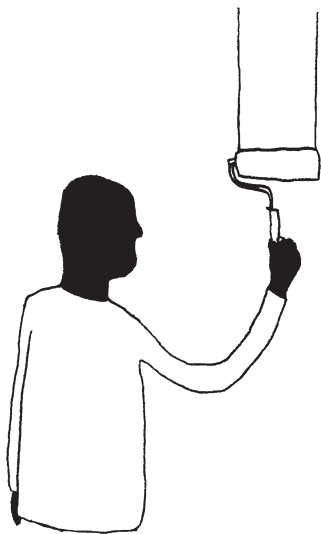





ALUMINIUM

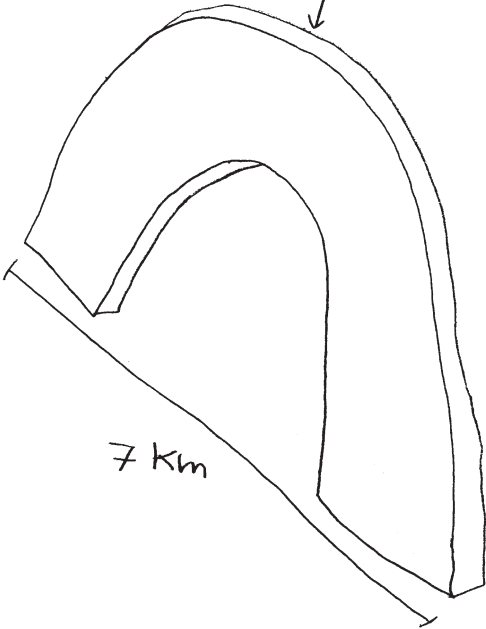

7 km

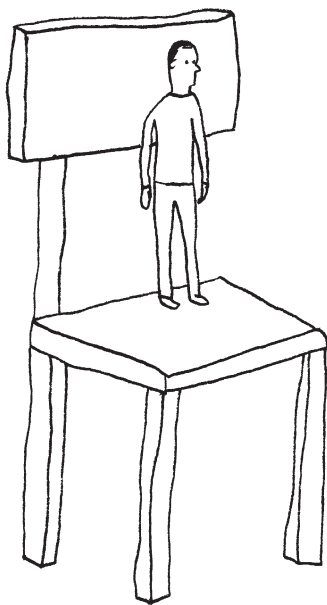

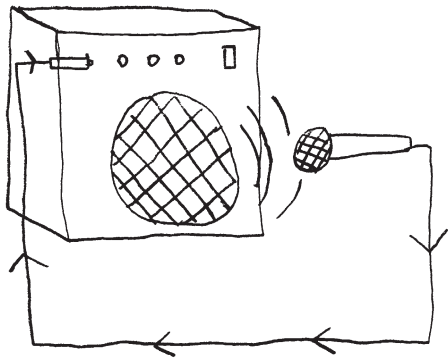

dans 4 heures  
je suis au lit







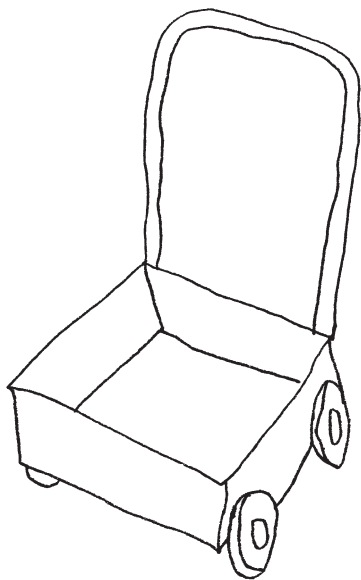

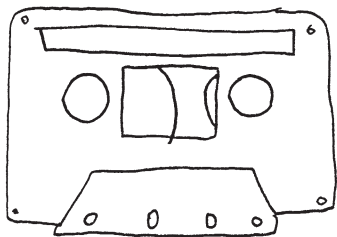

LES CASSETTES  
C'EST BIEN



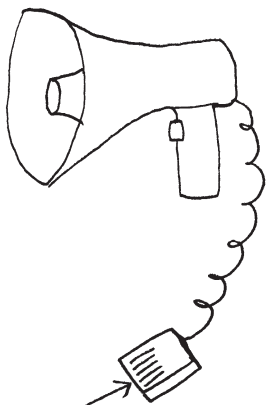

les  
secrets

LES CHOSES FACILES  
À DESSINER

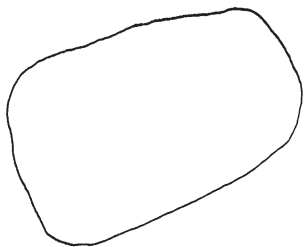

ma gomme

TABLE

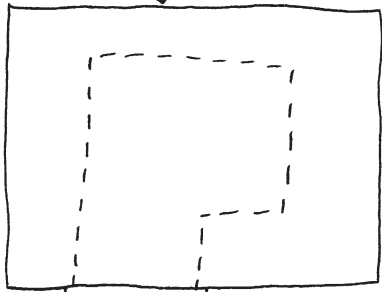

Tiroir



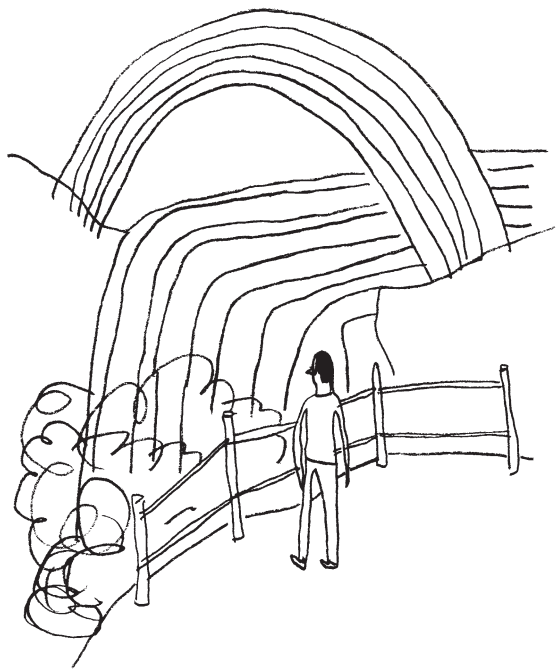

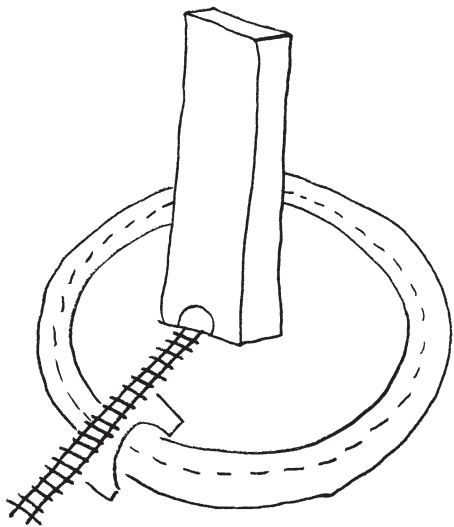

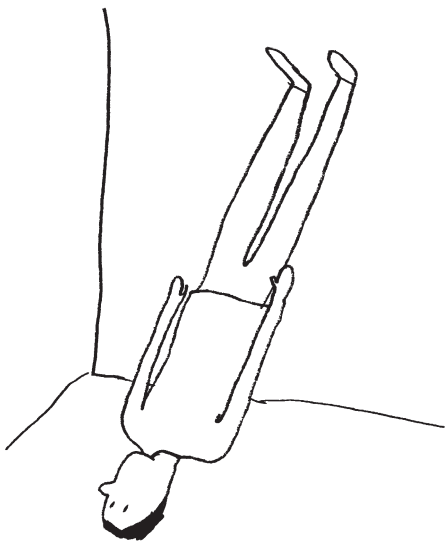

contre la migraine

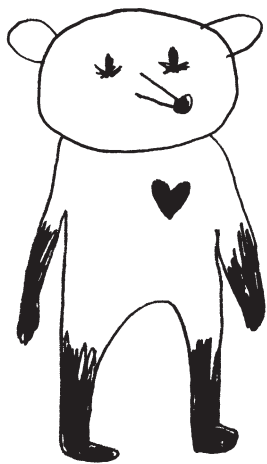





YOYO

V/S

RUBIK  
CUBE

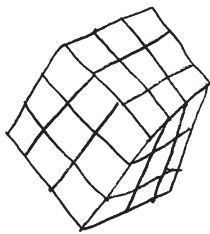

FELICITATION!

VOUS AVEZ GAGNÉ

50 MILLIONS

D'ANNÉES DE MALHEUR.  
(et quand ce sera fini  
les dinosaures seront  
revenus)

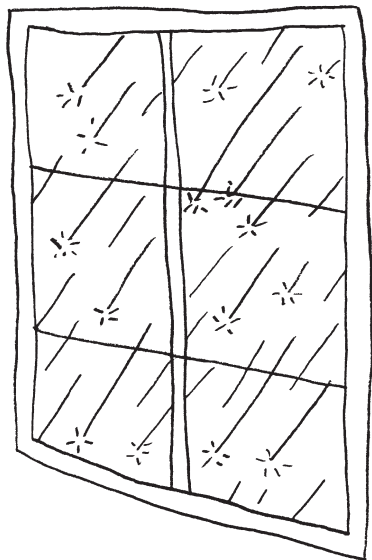

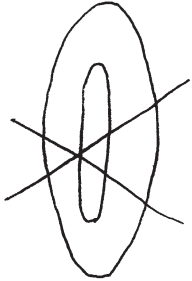

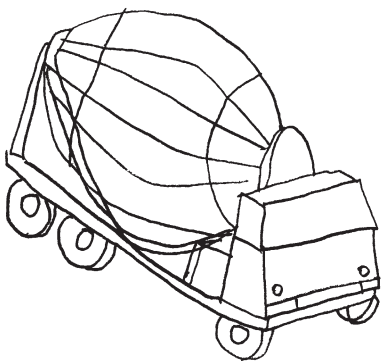

des tonnes de béton

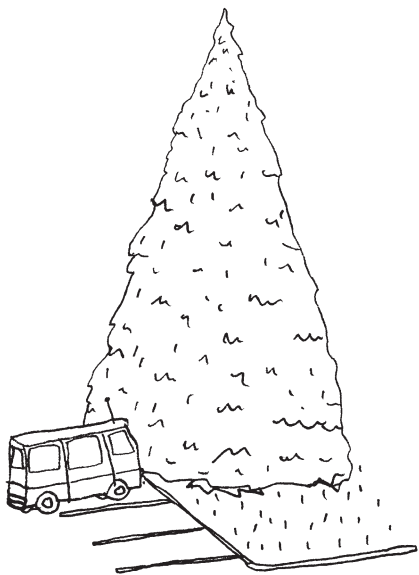

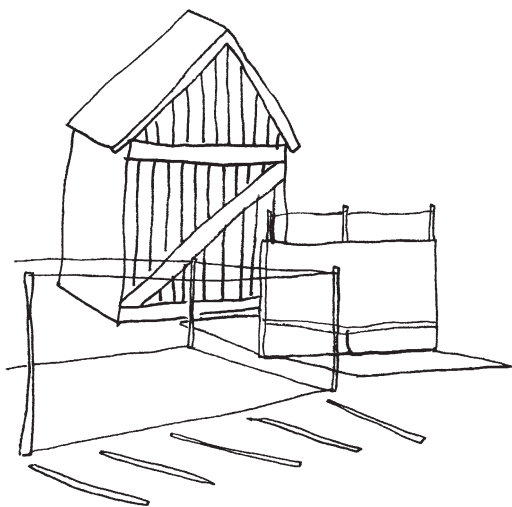



MEUDON

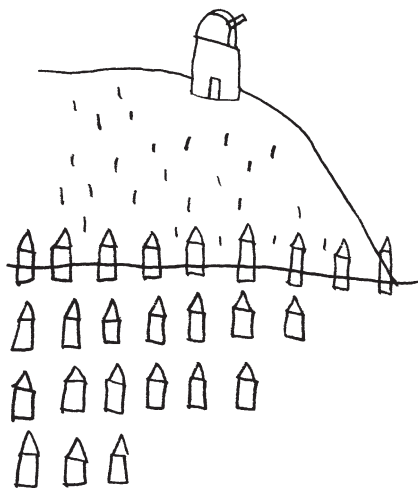



## DEPUIS ADÈLE

Je ne bois plus de café  
ou lait le matin,



Je mange des crêpes au  
goûter (avec du chocolat)

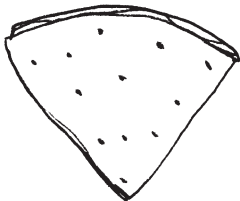

it was  
the biggest  
cock ...



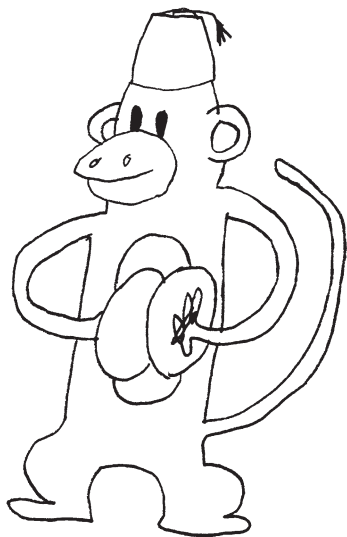

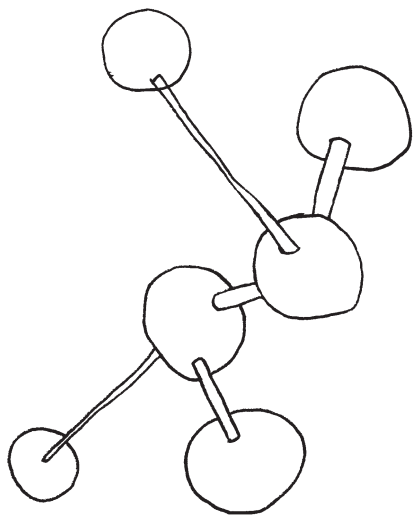

je suis  
Han Solo

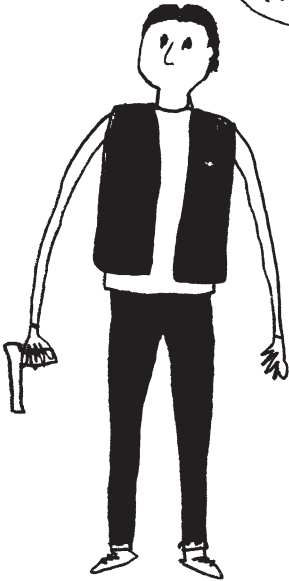

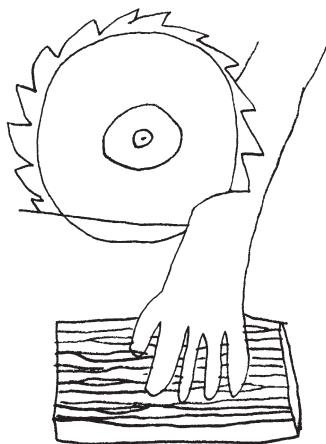



# LE MILLE-FEUILLE

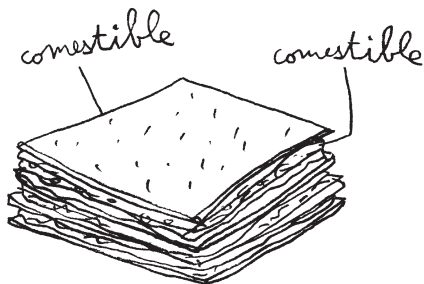

C'EST UN PEU COMME  
DES LASAGNES MAIS  
EN GATEAU.



moi, j'aime  
ma femme.

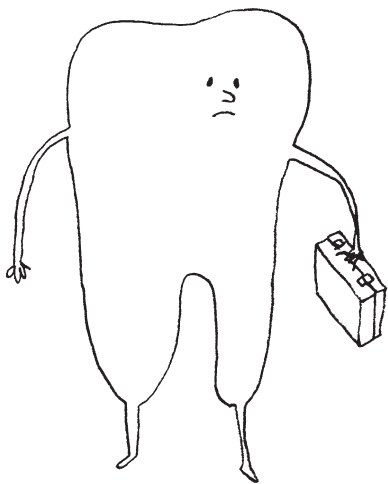

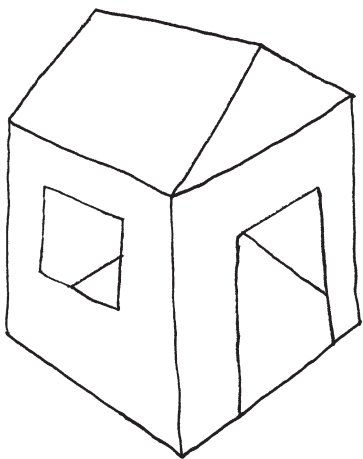

UN FOYER

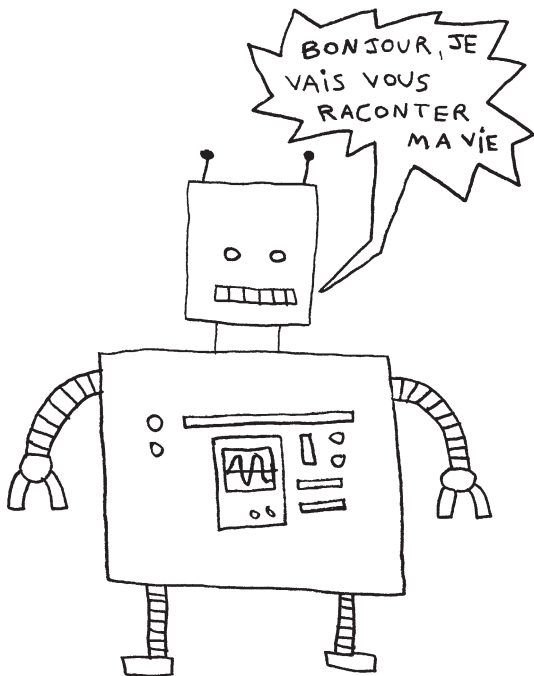

BONJOUR, JE  
VAIS VOUS  
RACONTER  
MA VIE

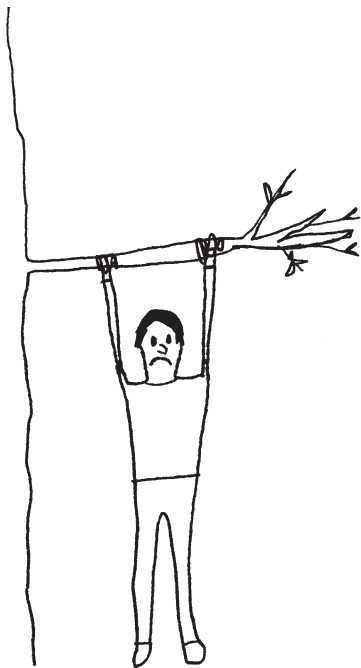

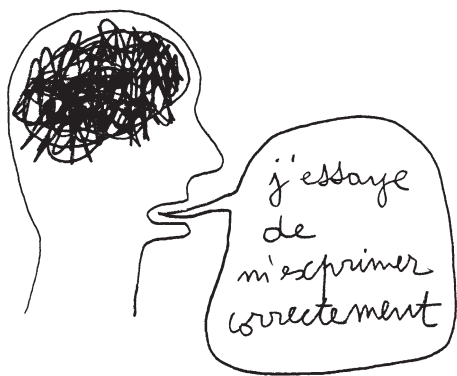

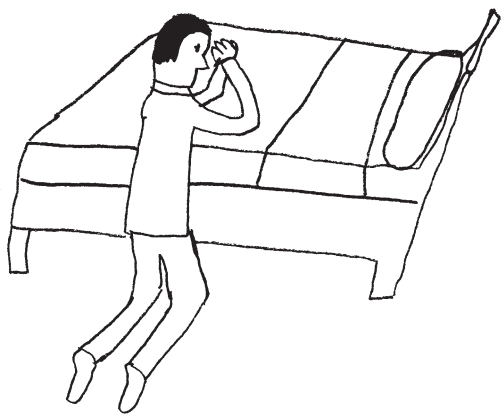



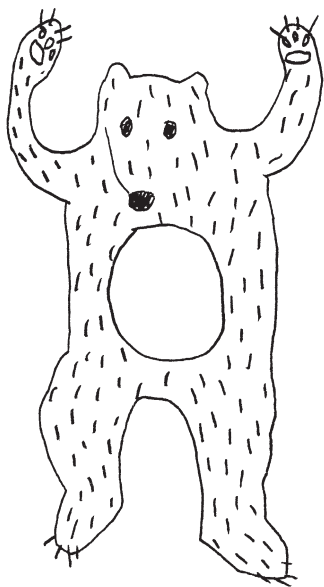

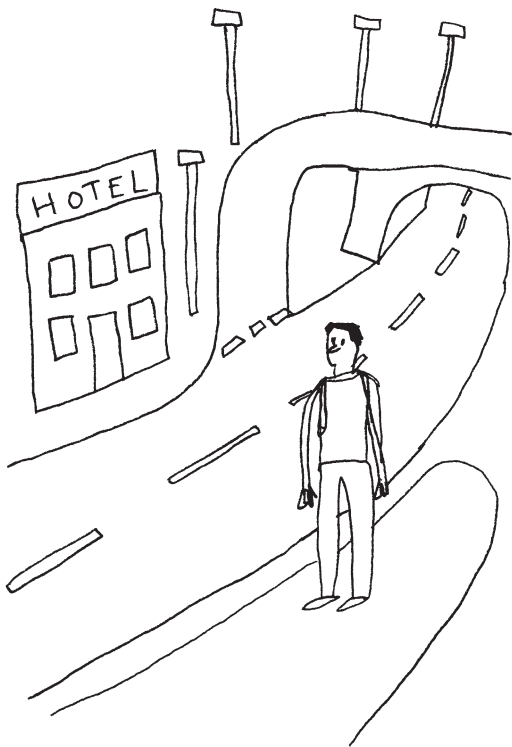

PARFUM  
PIZZA

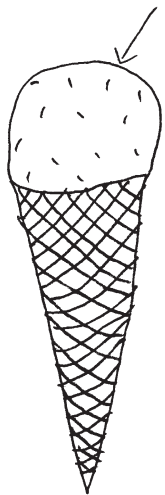

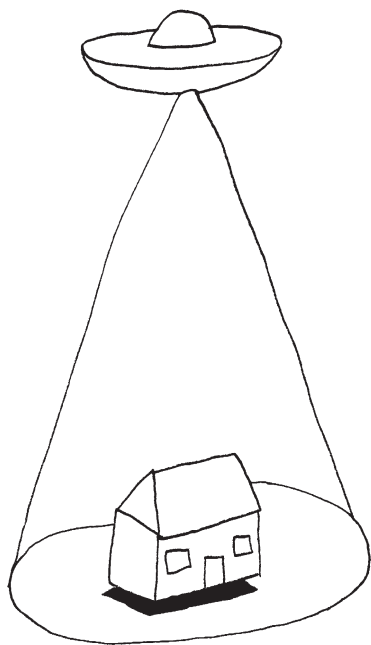





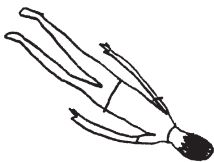
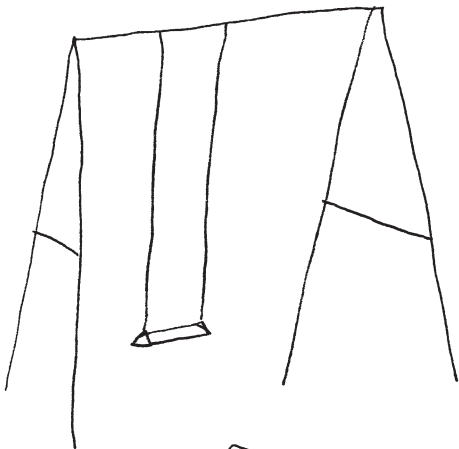

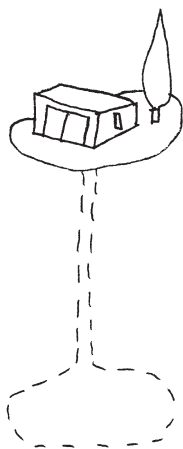



brûlures de cigarette

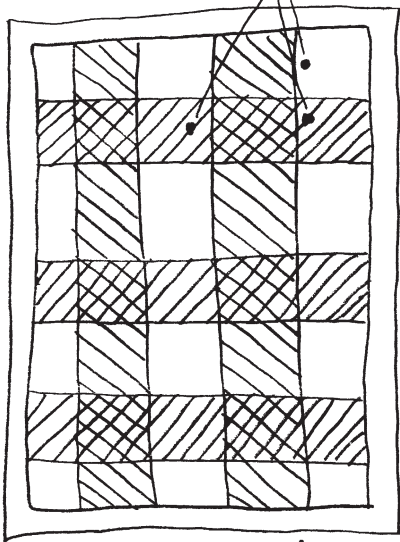

PLAID SOL LE WITT

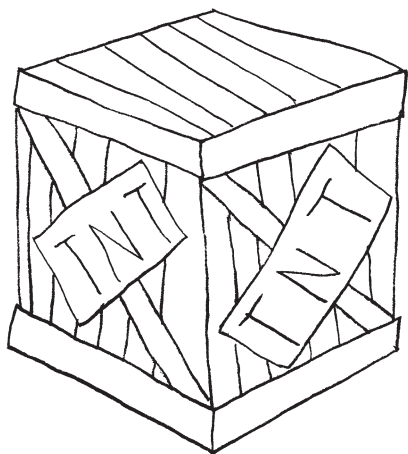

CONSEIL À LA  
JEUNESSE

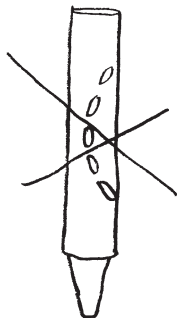

IL NE FAUT PAS MANGER  
LES CRAYONS



le  
dimanche  
j'ai le  
droit



toute  
la journée  
en  
pyjama

MIEUX QU'UN  
CONCEPT:



LA GRAISSE



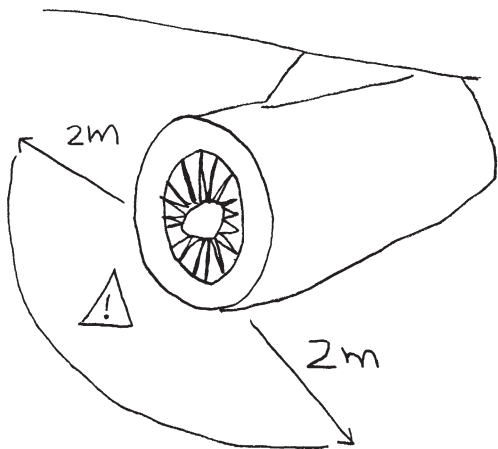



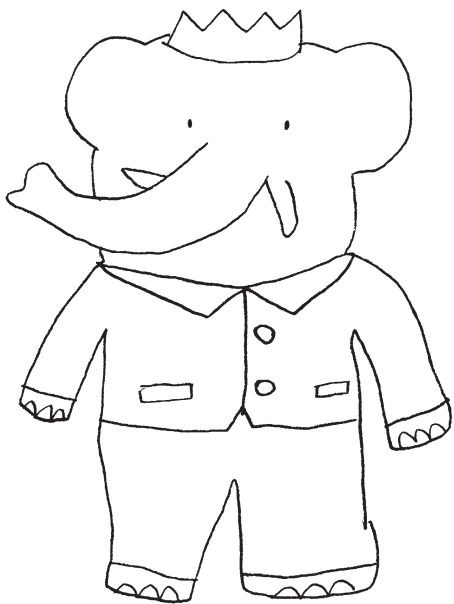

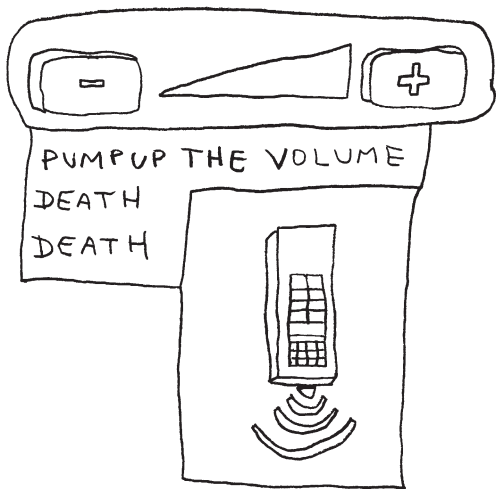

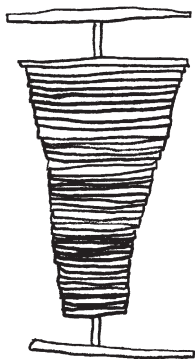

WELCOME TO  
KEBABLAND



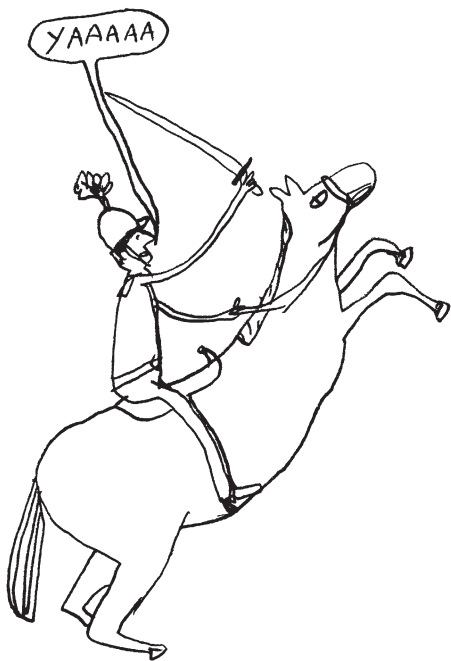

ANGST

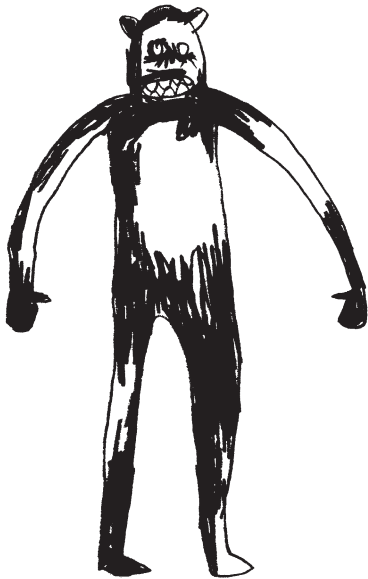









LES CHOSES PAS SI  
FACILES QUE ÇA À  
(BIEN) FAIRE.

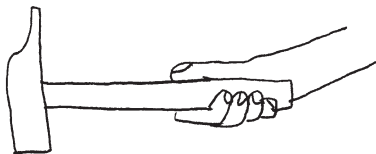

planter un clou droit

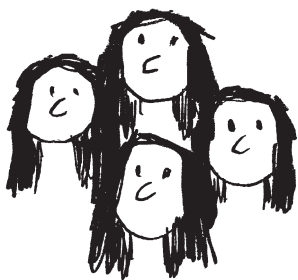

QUEEN



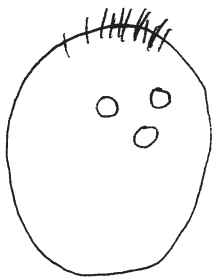

COCO NUT



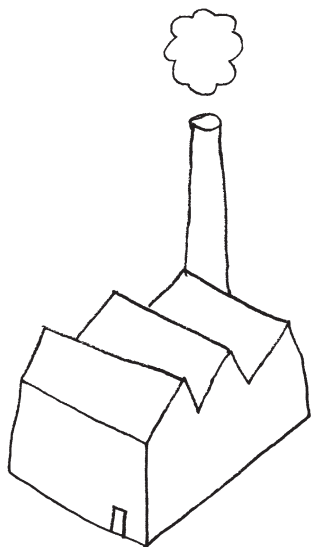

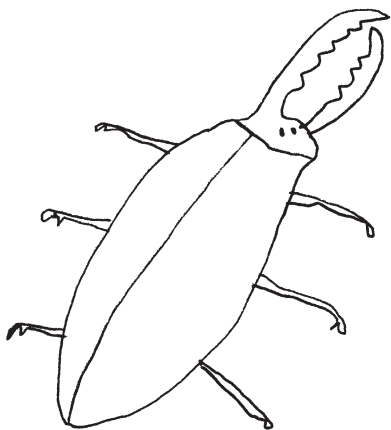



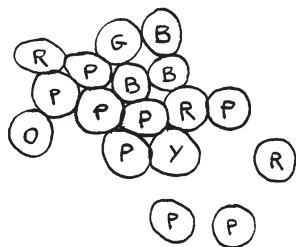

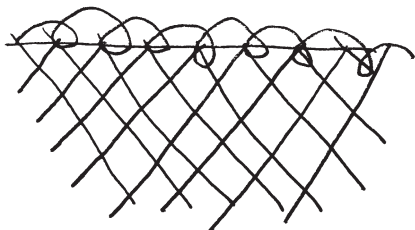
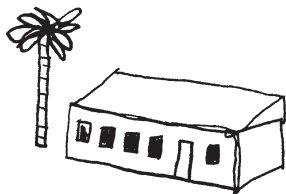



Je sais où  
vous habitez

la la la la  
crevez tous en enfer  
la la la la la

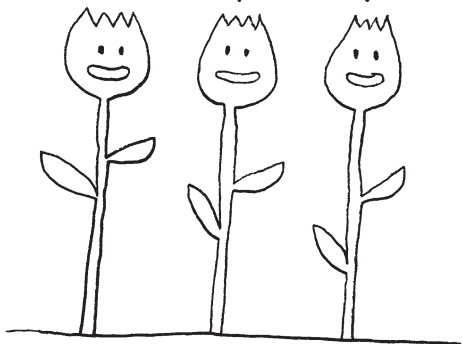



ROCK  
ON  
CHICAGO

ROCK  
OVER  
LONDON





TOC TOC  
TOC

qui est Là?

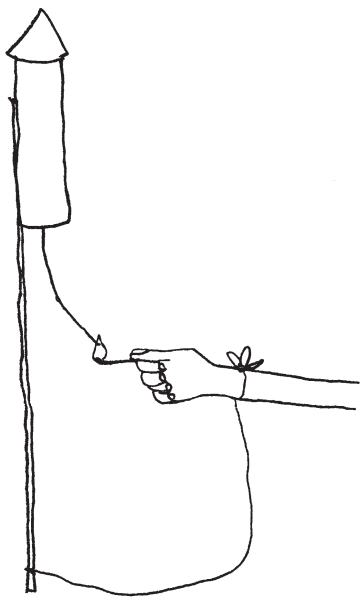

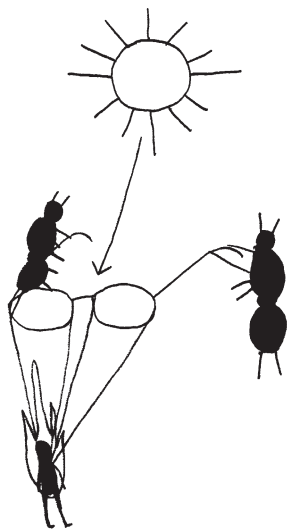



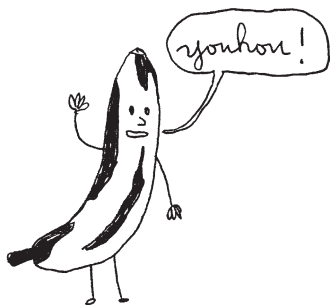

CHIQUITA  
LE SYMBOLE  
PHALLIQUE

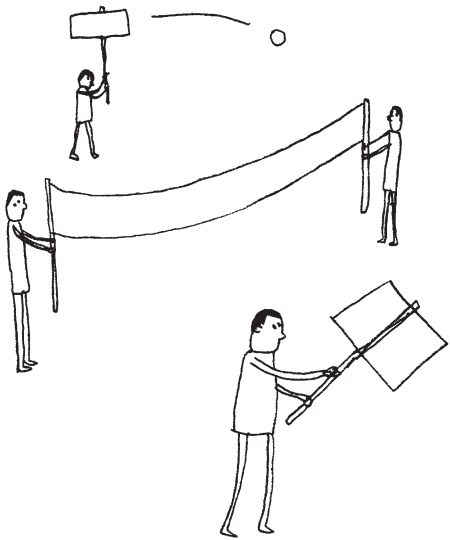

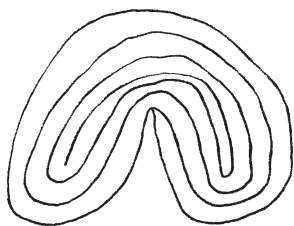

PALMITO



BILD est publiée par l'auteur  
spéciale dédiée à F. Fleury et E. Bidoux.

MES DESSINS  
SONT TRÈS LAÏDS.  
JE MÉRITE LA  
MORT:

VRAI

FAUX